

16 ports Console Server

CSE-T16 User Manual

Version 1.3



Sollae Systems Co., Ltd.

<https://www.ezTCP.com>



This symbol, found on your product or on its packaging, indicates that this product should not be treated as household waste when you wish to dispose of it. Instead, it should be handed over to an applicable collection point for the recycling of electrical and electronic equipment. By ensuring this product is disposed of correctly, you will help prevent potential negative consequences to the environment and human health, which could otherwise be caused by inappropriate disposal of this product. The recycling of materials will help to conserve natural resources. For more detailed information about the recycling of this product, please contact your local city office, household waste disposal service or the retail store where you purchased this product.

※ This equipment obtained certification by using 1.5M serial cable.

Contents

1	Overview	- 5 -
1.1	Overview.....	- 5 -
1.2	Features.....	- 5 -
1.3	Application Examples	- 6 -
1.4	Specification.....	- 7 -
1.4.1	<i>Hardware</i>	- 7 -
1.4.2	<i>Software</i>	- 7 -
1.5	Dimensions.....	- 8 -
1.6	Interface.....	- 9 -
1.6.1	<i>Panel Layout</i>	- 9 -
1.6.2	<i>Serial Port</i>	- 10 -
1.6.3	<i>Ethernet Port</i>	- 11 -
1.6.4	<i>Console Port</i>	- 12 -
1.6.5	<i>Power</i>	- 12 -
1.6.6	<i>System LED indicators</i>	- 12 -
1.6.7	<i>Function Button</i>	- 12 -
2	Installation and Test	- 13 -
2.1	Installation	- 13 -
2.1.1	<i>Setting Network Area</i>	- 14 -
2.2	Simple Test	- 17 -
2.2.1	<i>Simple Test</i>	- 17 -
3	Configuration	- 20 -
3.1	Configuration with ezManager	- 20 -
3.1.1	<i>Configuration</i>	- 20 -
3.2	Initial Setup by using Console	- 22 -
4	Communication mode	- 23 -
4.1	Normal Communication Mode.....	- 23 -
4.2	TCP Server	- 24 -
4.2.1	<i>Key parameters</i>	- 24 -
4.2.2	<i>Examples</i>	- 25 -
4.3	TCP Client.....	- 27 -
4.3.1	<i>Key parameters</i>	- 27 -
4.3.2	<i>Examples</i>	- 28 -

4.4	UDP	- 30 -
4.4.1	Key parameters	- 30 -
4.4.2	Examples	- 31 -
5	System Management.....	- 33 -
5.1	Upgrading Firmware	- 33 -
5.1.1	Firmware.....	- 33 -
5.1.2	Process.....	- 33 -
5.2	Status Monitoring through Shell command.....	- 35 -
5.2.1	How to connect.....	- 35 -
5.2.2	Shell Commands for Initial Setup	- 39 -
5.2.3	Shell Commands for Monitoring Status.....	- 39 -
5.3	Status Window of ezManager	- 41 -
5.3.1	Status.....	- 41 -
5.4	Factory Reset.....	- 43 -
5.4.1	How to reset	- 43 -
5.4.2	Sequence of LED operation	- 43 -
6	Security functions	- 44 -
6.1	SSL.....	- 44 -
6.1.1	SSL(Secure Socket Layer).....	- 44 -
6.1.2	How to set SSL.....	- 44 -
6.1.3	Restriction.....	- 47 -
6.2	Setting password.....	- 47 -
7	Additional Functions.....	- 48 -
7.1	CSE-T16 Tab Functions	- 48 -
7.1.1	TCP+TENLET - ①	- 48 -
7.1.2	Separator - ②.....	- 49 -
7.1.3	Checking an option	- 50 -
7.2	Option tab functions	- 51 -
7.2.1	Notify Ipv4 Change.....	- 51 -
8	Technical Support and Warranty.....	- 52 -
8.1	Technical Support.....	- 52 -
8.2	Warranty	- 52 -
8.2.1	Refund.....	- 52 -
8.2.2	Free Repair Services.....	- 52 -
8.2.3	Charged Repair Services.....	- 52 -

9	Precaution and Exemption from Liability	- 53 -
9.1	Precaution	- 53 -
9.2	Exemption from Liability	- 54 -
9.2.1	<i>English version</i>	- 54 -
9.2.2	<i>French version</i>	- 55 -
10	Revision History	- 57 -

1 Overview

1.1 Overview

CSE-T16 is a 16-port console server allowing devices with console ports to be embedded with networking capabilities. With CSE-T16, therefore, you can easily monitor status of console ports over the network from anywhere in the world. It also helps you save your time and energy by improving efficiency of integrated management and control of many devices in diverse applications.

This RS232 console server is an ideal solution for Remote Console Monitoring as it supports useful features such as 16 ports of RS232, a security protocol(SSL) to protect data transmission, sharing serial ports through the network(Telnet with RFC2217), etc.

1.2 Features

- 16 x RS232 (RJ45, up to 115,200bps)
- Security Functions (SSL 3.0 / TLS 1.0, Password)
- 3 Communication modes (TCP Server, TCP Client and UDP)
- Support of DHCP for DSL and cable network
- A variety of ways to monitor communication status (ezManager, TELNET)
- Powerful management software for Windows OS (ezManager)
- Firmware upgrade through Network

1.3 Application Examples

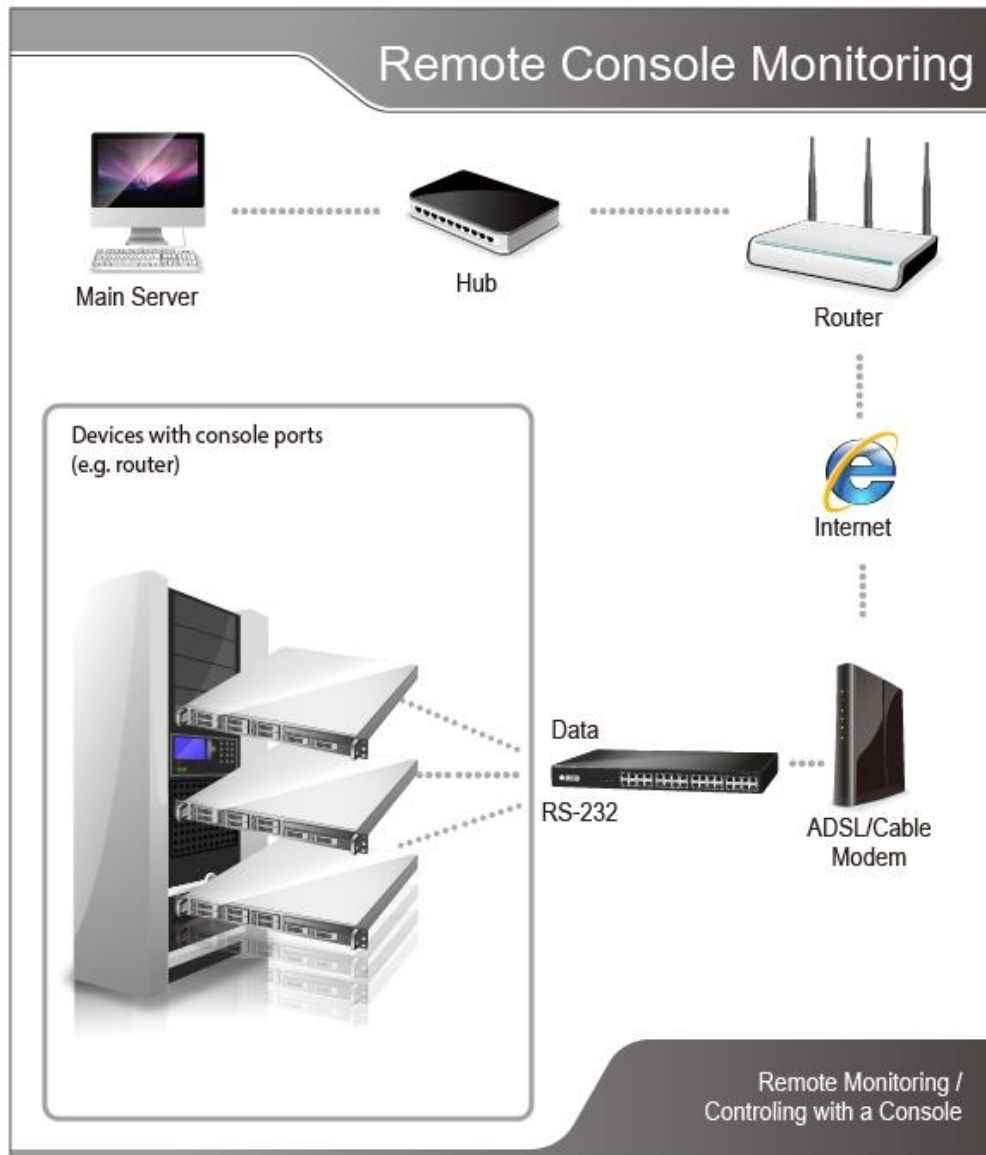

Figure 1-1 CSE-T16 Application

1.4 Specification

1.4.1 Hardware

Power	Input Voltage	AC 85V~264V
	Power Consumption	7W
Dimension	435mm X 240mm X 45mm	
Weight	About 2.7Kg	
Interface	Serial Port	16 × RS232 – RTS/CTS Flow control (Baud Rate: 300bps ~ 115,200bps)
	Ethernet Port	Ethernet 10Base-T or 100Base-TX (Auto-Sensing) Auto MDI/MDIX
	Console Port	1 x D-sub port (Male type), 115,200bps
Temperature	Operating: -20 ~ 70°C / Storage: 0 ~ 60°C	
Approval	-	
RoHS	RoHS Compliant	

Table 1-1 hardware specification

1.4.2 Software

Protocol	TCP, UDP, IP, ICMP, ARP, DHCP, DNS lookup, DDNS(Dynamic DNS), Telnet, SSL	
Operation mode	Normal	For Normal Data Communication
Communication mode	TCP Server	TCP Passive Connection
	TCP Client	TCP Active Connection
	UDP	UDP
Major Utilities	ezManager	Configuration Utility for MS Windows (Firmware download)
	ezVSP	Serial to TCP/IP Virtual driver for MS Windows

Table 1-2 software specification

1.5 Dimensions

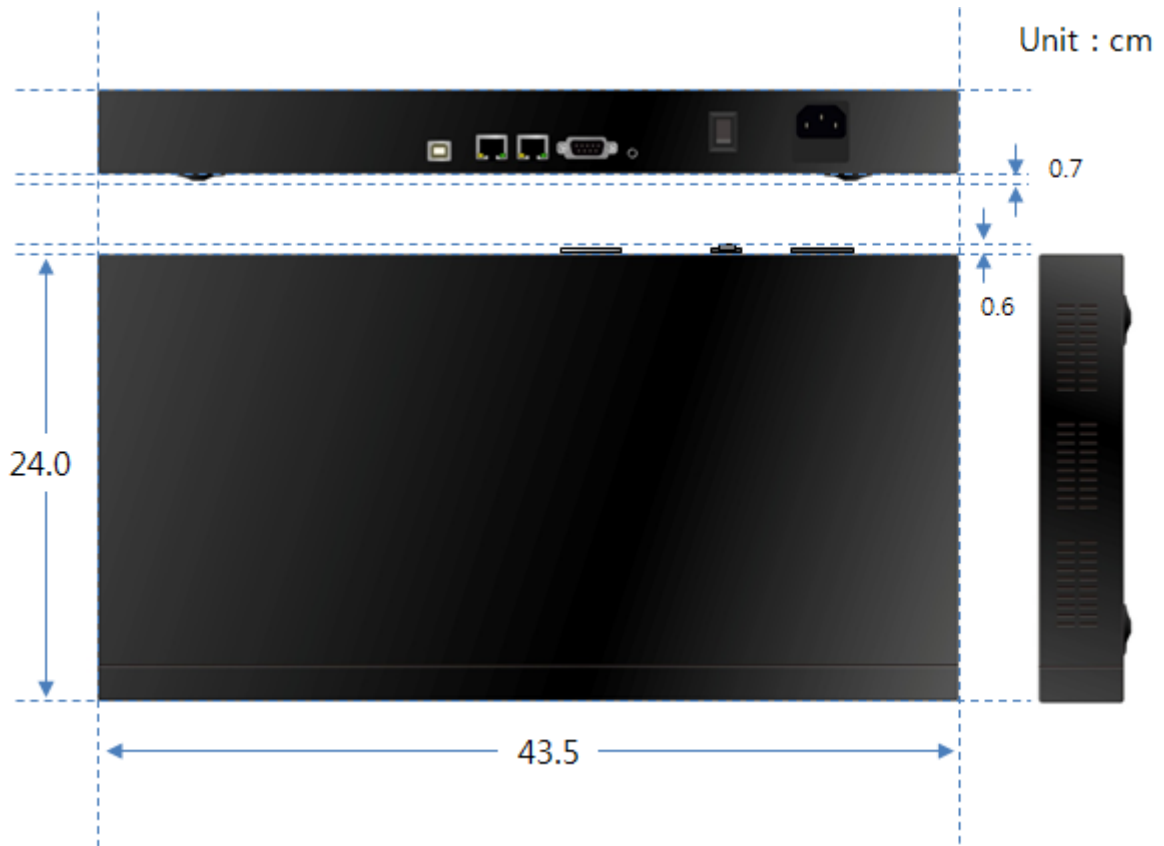

Figure 1-2 dimensions

1.6 Interface

1.6.1 Panel Layout

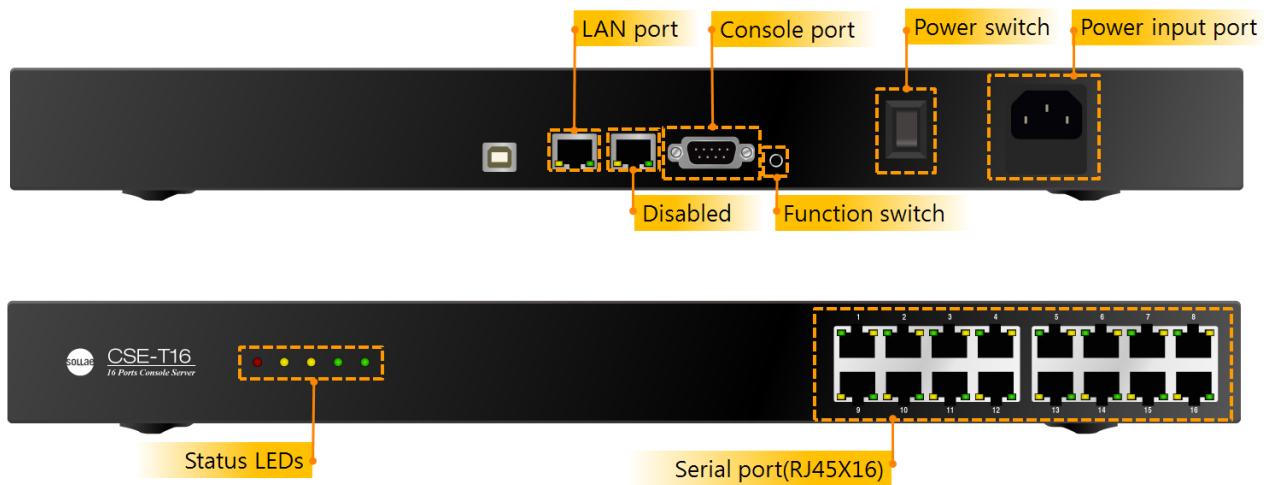

Figure 1-3 panel layout

1.6.2 Serial Port

CSE-T16 has 16 of RJ45-typed connectors for RS232 and it can be communicated with 300bps ~ 115,200bps.



Figure 1-4 RJ45 connector for serial port

- Serial port(RJ45)

Number	Name	Description	Level	I/O	Wiring
1	RTS	Request To Send	RS232	Out	Optional
2	DTR	Data Terminal Ready	RS232	Out	Optional
3	TXD	Transmit Data	RS232	Out	Required
4	GND	Ground	Ground	-	Required
5	GND	Ground	Ground	-	Required
6	RXD	Receive Data	RS232	In	Required
7	DSR	Data Set Ready	RS232	In	Optional
8	CTS	Clear To Send	RS232	In	Optional

Table 1-3 serial port (RJ45)

- LEDs of serial port

Color	LED Status	Operation
Yellow	On	DSR (COM port is ready to communicate)
	Blinking	CSE-T16 is sending data to the serial device
Green	On	DTR (TCP connection is being established)
	Blinking	CSE-T16 is getting data from the serial device

Table 1-4 LEDs of serial port

- Flow control

CSE-T16 supports RTS/CTS Hardware Flow Control.

1.6.3 Ethernet Port

Network part of CSE-T16 is configured with Ethernet. So, what you have to do is only to connect UTP cable. The Ethernet part detects 10Mbit or 100Mbit Ethernet automatically, to connect the corresponding cable. It also provides auto MDI/MDIX function to detect 1:1 cable or cross-over cable automatically.



Figure 1-5 RJ45 connector for Ethernet port

- Ethernet port interface (RJ45)

Number	Name	Type
1	TX+	OUT
2	TX-	OUT
3	RX+	INPUT
4	-	-
5	-	-
6	RX-	INPUT
7	-	-
8	-	-

Table 1-5 RJ45 the Ethernet port interface

- LED indicator of RJ45

Color	LED status	Description
Green	On	Connected to network
	Off	Not connected to network
	Blinking	Receiving or transmitting network data
Yellow	On	Connected to 100M Ethernet
	Off	Connected to 10M Ethernet

Table 1-6 LED indicator of RJ45

1.6.4 Console Port

The console port is used for initial configuration or status checking of the product. Connect this port to your PC and access it through a terminal program at 115,200 bps.

1.6.5 Power

AC85V ~ AC264V is used for the power.

1.6.6 System LED indicators

There are 5 system LED indicators operating as follows:

Name	Color	Status	Description
PWR	Red	On	Power is supplied
STS1	Yellow	Blinking in every second	Obtaining an IP address
		Blinking 4 times at once	Without obtaining an IP address by DHCP
STS2	Yellow	Blinking quickly	Initializing the serial port
		On	Serial port initializing complete
LAN1	Green	On	Connected to the network
		Off	Not connected to the network
		Blinking	Data exchanging in the network
LAN2	-	-	Disable

Table 1-7 System LED indicators

1.6.7 Function Button

The Function button is used to reset the product's configuration values. Refer to section 5.4 for more details.

2 Installation and Test

2.1 Installation

Before testing CSE-T16, users should connect CSE-T16's Ethernet port to PC. It will be no problem that the Ethernet connection includes network hubs. It also needs to connect one of 16 serial ports to PC via a serial cable.

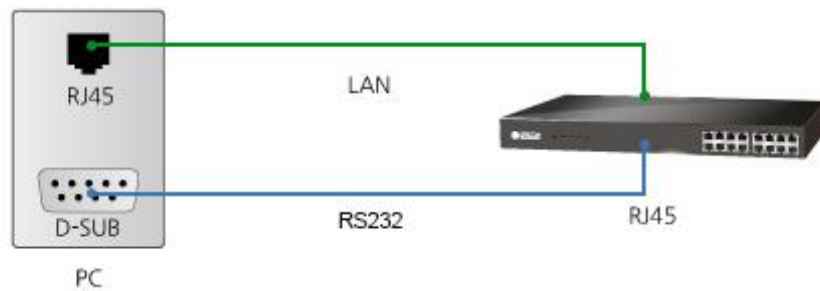

Figure 2-1 Connection between CSE-T16 and a PC

☞ *In case if your PC doesn't have a RS232 port, use a USB to RS232 cable.*

2.1.1 Setting Network Area

This procedure should be followed to make CSE-T16 and your PC located on the same network for a TCP connection.

- IP address of PC setting

Add or change the IP address of the network adapter on your PC like following.

Click [Windows Control Panel] >> [Network Connections] and [Properties of the Network Adapter]. Then, you can see the properties of [Internet Protocol (TCP/IP)]. Press the [Advanced] button and add an IP Address like the figure below.

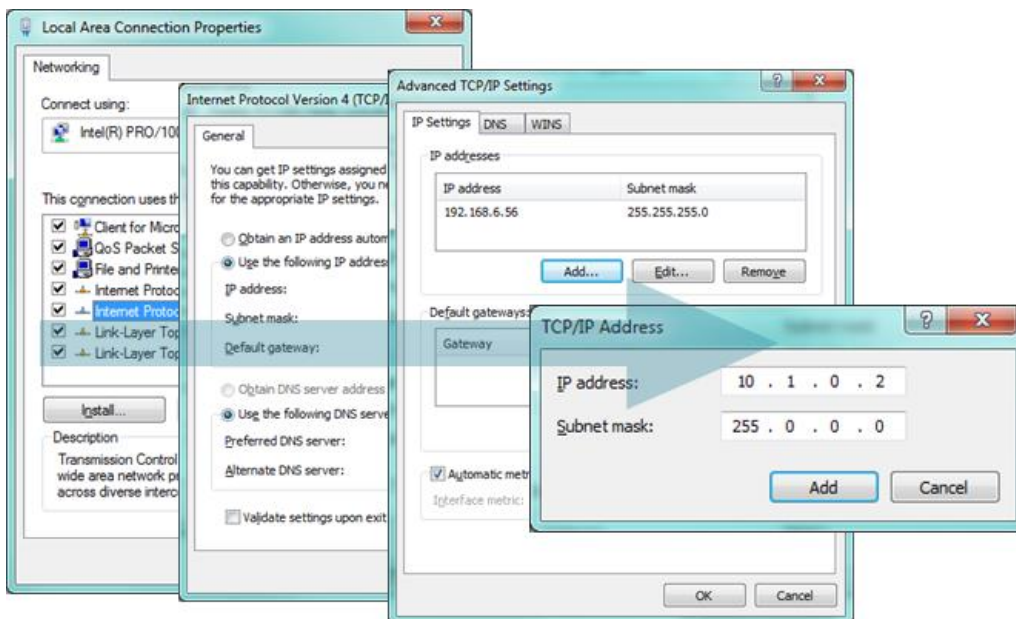

Figure 2-2 setting PC

- CSE-T16 settings

ezManager comes with CSE-T16 as a configuration tool. This MS Windows-based software is easy to use and does not need installation.

For simple test, we recommend that the variables keep default values as shown in the below table.

Name		Default values
Network	Local IP Address	10.1.0.1
	Subnet Mask	255.0.0.0
Serial Port (COM1~16)	Baud Rate	19,200bps
	Parity	NONE

	Data Bits	8
	Stop Bit	1
	Flow control	NONE
	Communication Mode	TCP Server – T2S
	Local Port	14701~14716
Option	Telnet	Enabled
	IPv4 Address Search	Enabled

Table 2-1 default values of major parameters

The following images show the configuration of serial ports on ezManager.

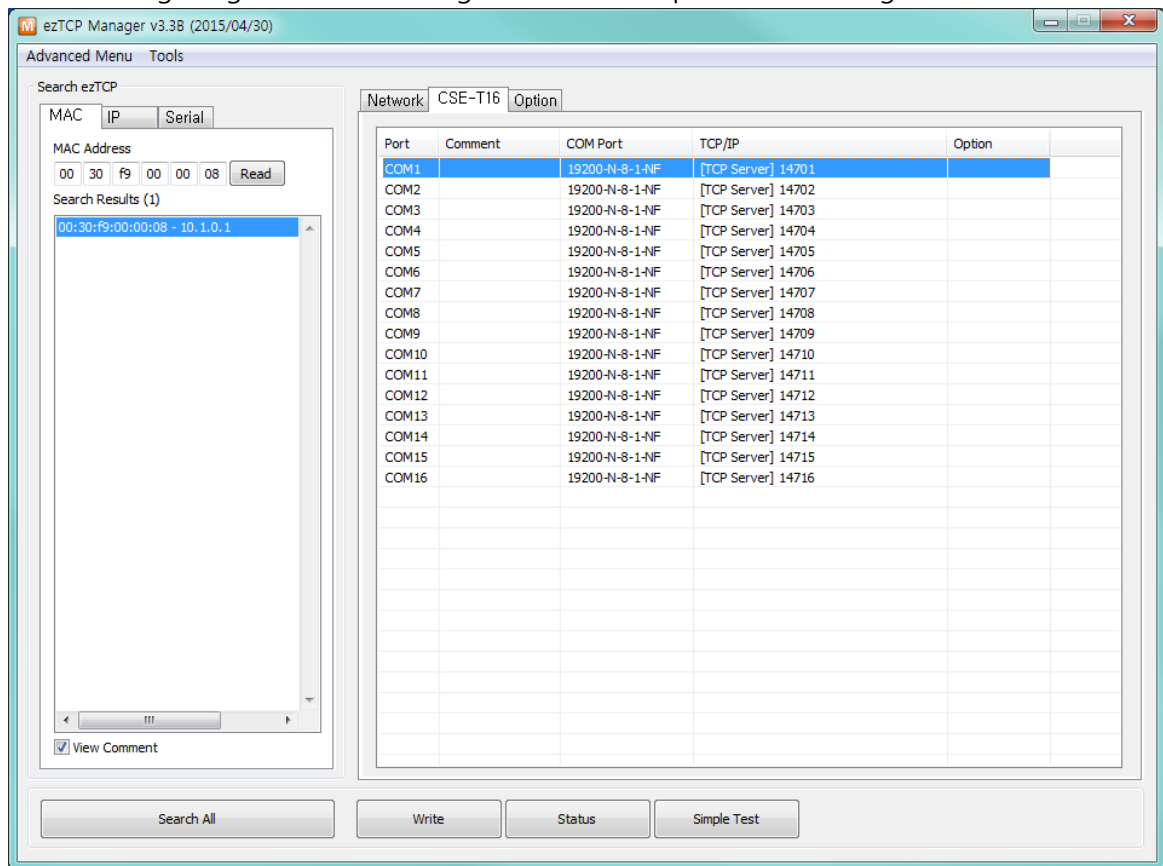

Figure 2-3 ezManager settings

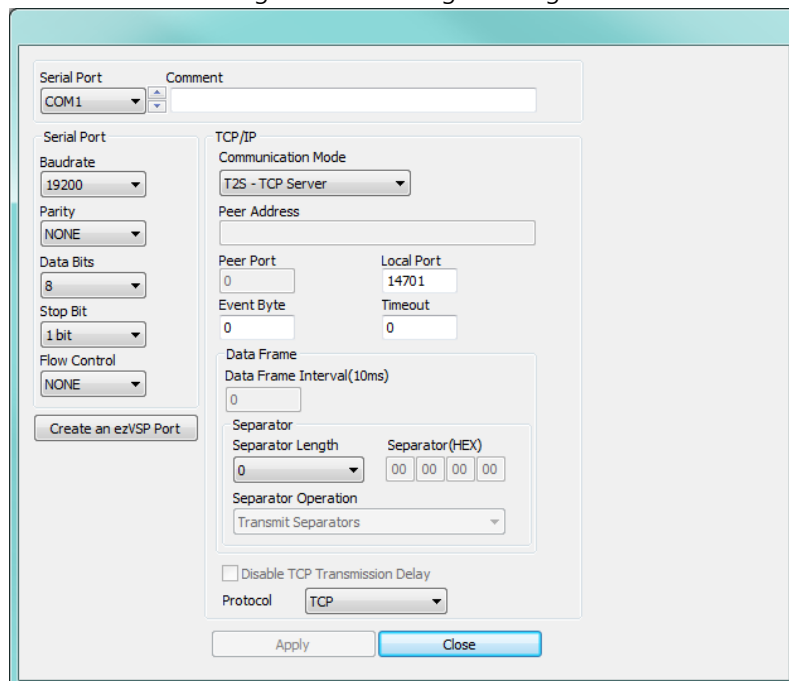

Figure 2-4 Basic settings of environmental variables

2.2 Simple Test

2.2.1 Simple Test

After CSE-T16 is connected to the network by checking green LED on LAN1, you may press [Simple Test] button on ezManager to see a test program as in the following Figure 2-4.

- Connecting to the CSE-T16 via LAN

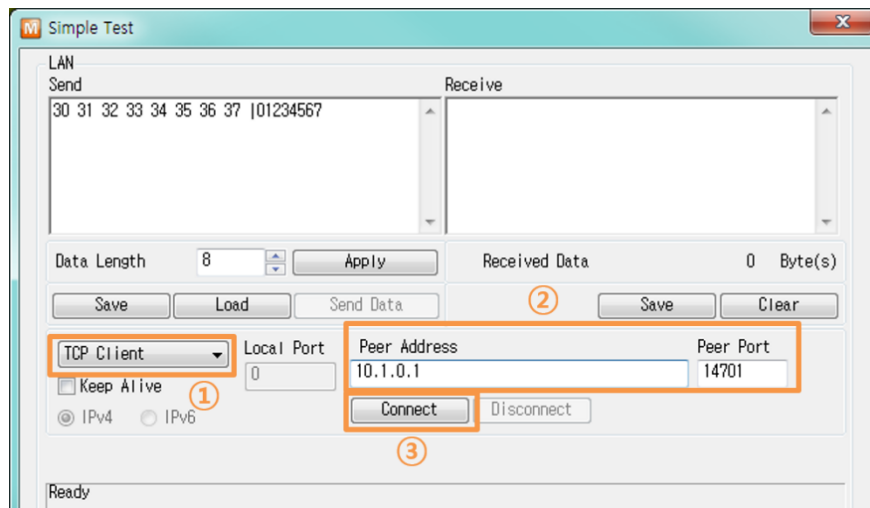

Figure 2-5 settings for TCP connection

- ① Select [TCP Client].
 - ② Input correct IP address and port number of CSE-T16 corresponding with the serial port, which are connected to PC
 - ③ Click [Connect] button. (In the case of TCP server, it will be the [Listen] button).
- Opening RS232 port

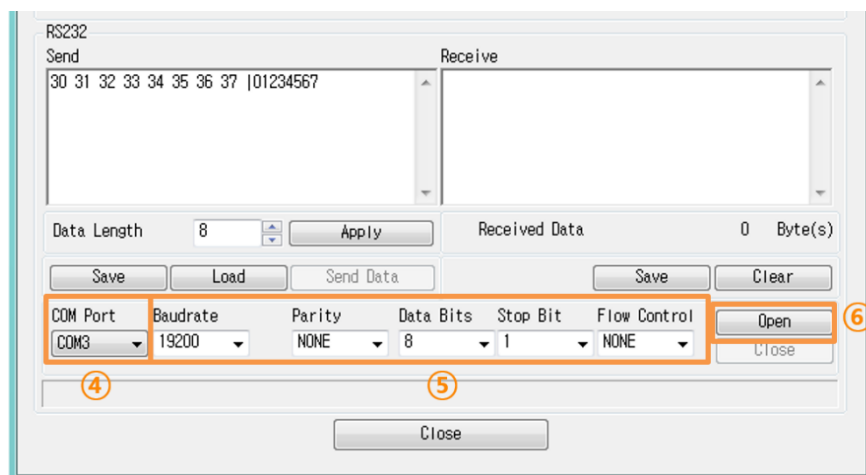

Figure 2-6 opening COM port

- ④ Select COM port of your PC where CSE-T16 is being connected.
- ⑤ Make sure that all the parameters are the same with CSE-T16.
- ⑥ Press the [Open] button.

- Confirm the TCP Connection and COM port status

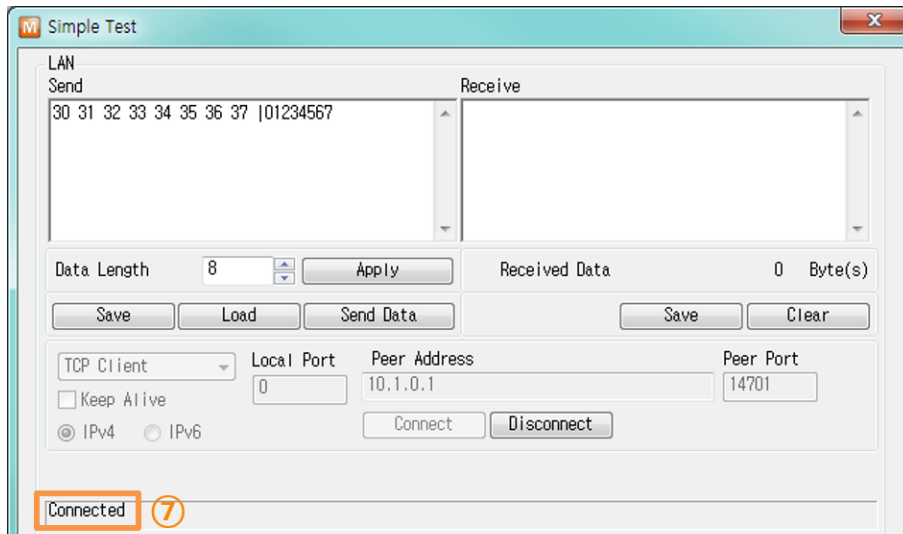

Figure 2-7 TCP connection message

- ⑦ Check the message if the TCP connection has been established well.

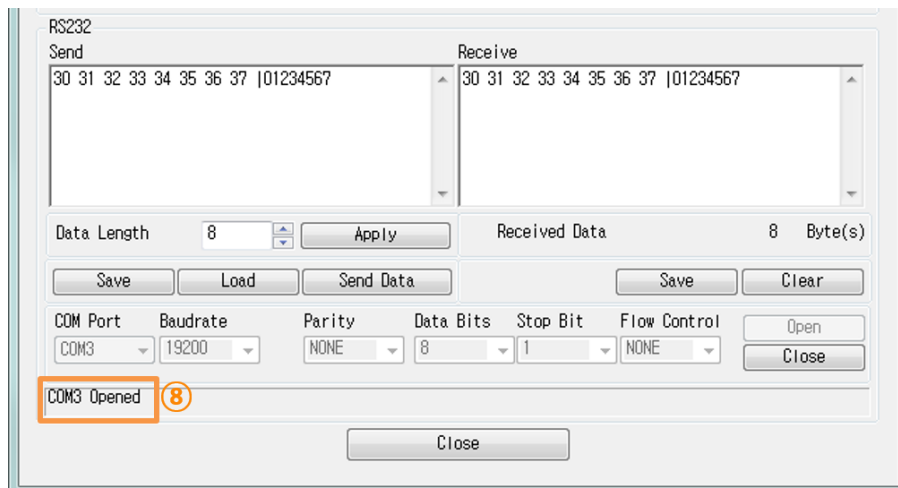

Figure 2-8 COM port open message

- ⑧ Check the message if the COM port has been opened.

- Data transmission test

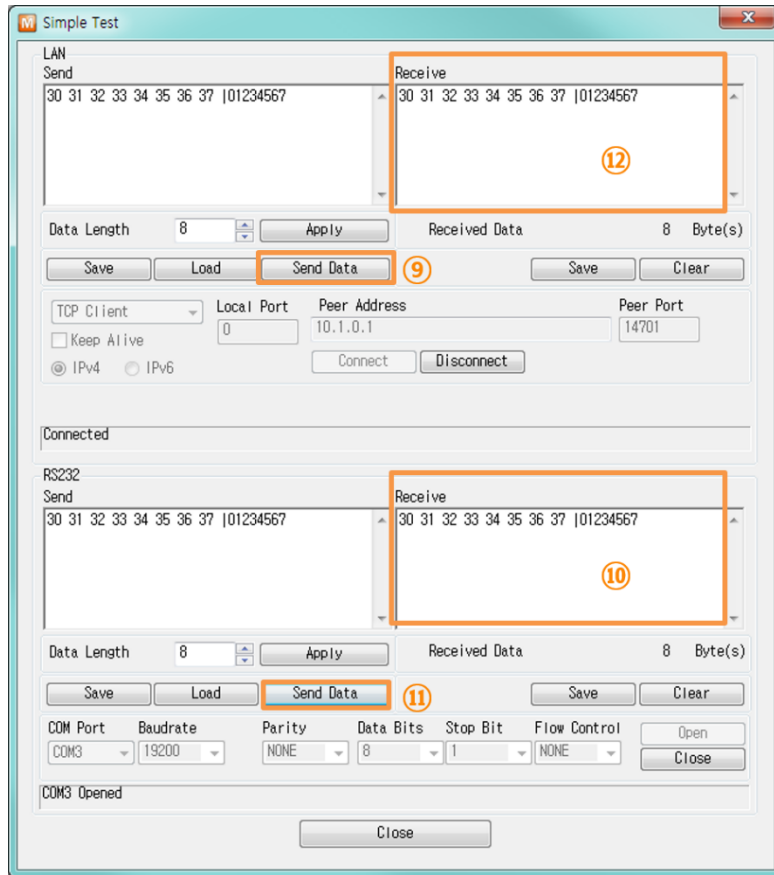

Figure 2-9 successful data transmission

- ⑨ Click [Send data] on the LAN side.
- ⑩ Check the data from ⑨ has been shown.

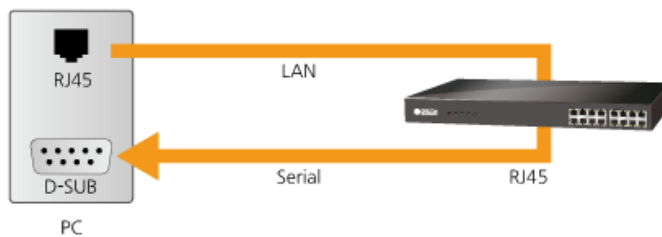

Figure 2-10 LAN → RS232

- ⑪ Press [Send data] on the RS232 side.
- ⑫ Check the data from ⑪ has been received.

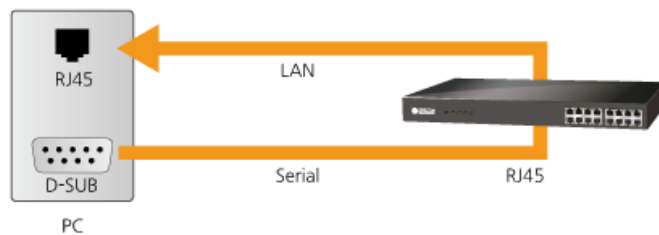

Figure 2-11 RS232 → LAN

3 Configuration

3.1 Configuration with ezManager

3.1.1 Configuration

- Requirements

Make sure of the connection between your PC and CSE-T16 via Ethernet. If they are in the same LAN network, [MAC Address search] button can be used. Otherwise, only [IP Address search] is allowed to use.

- Procedure

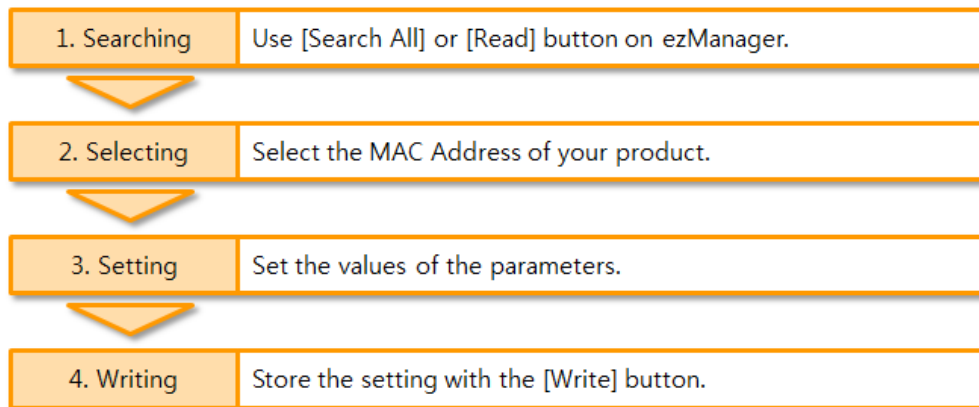

Figure 3-1 procedures for configuration via LAN

☞ *If a situation to read CSE-T16 via [IP] tab in ezManager, UDP 50005, the initial port number must be changed to 50007.*

- Ports settings

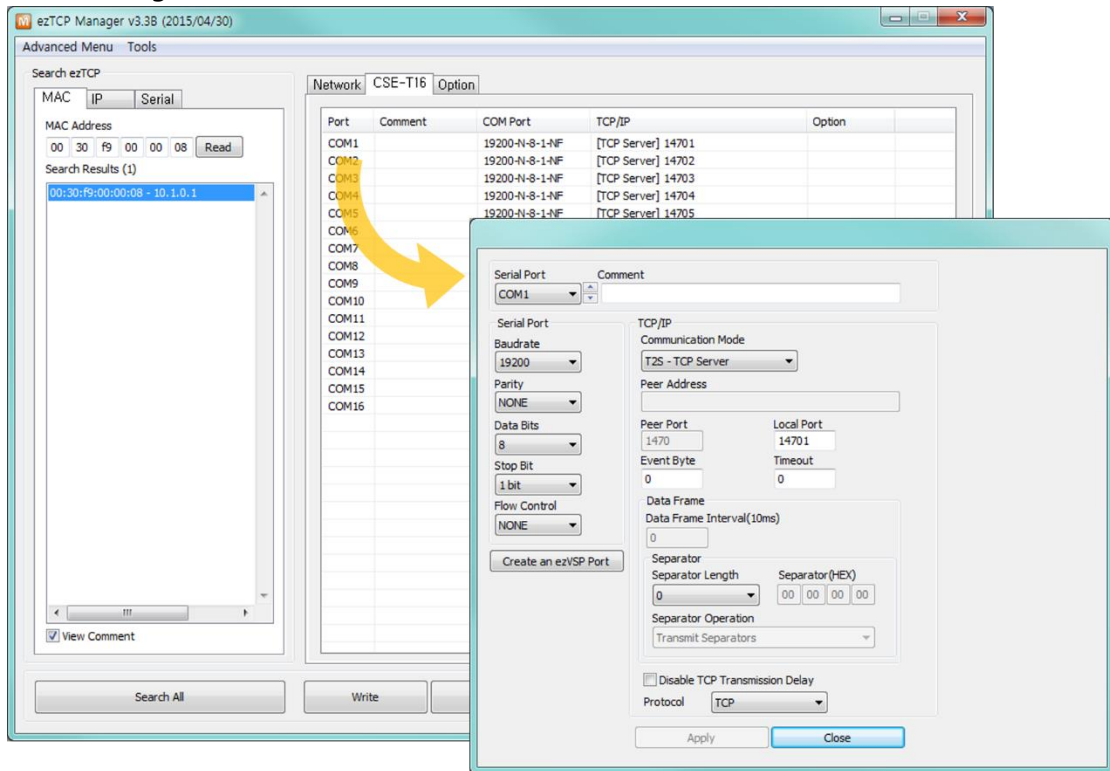

Figure 3-2 ports settings

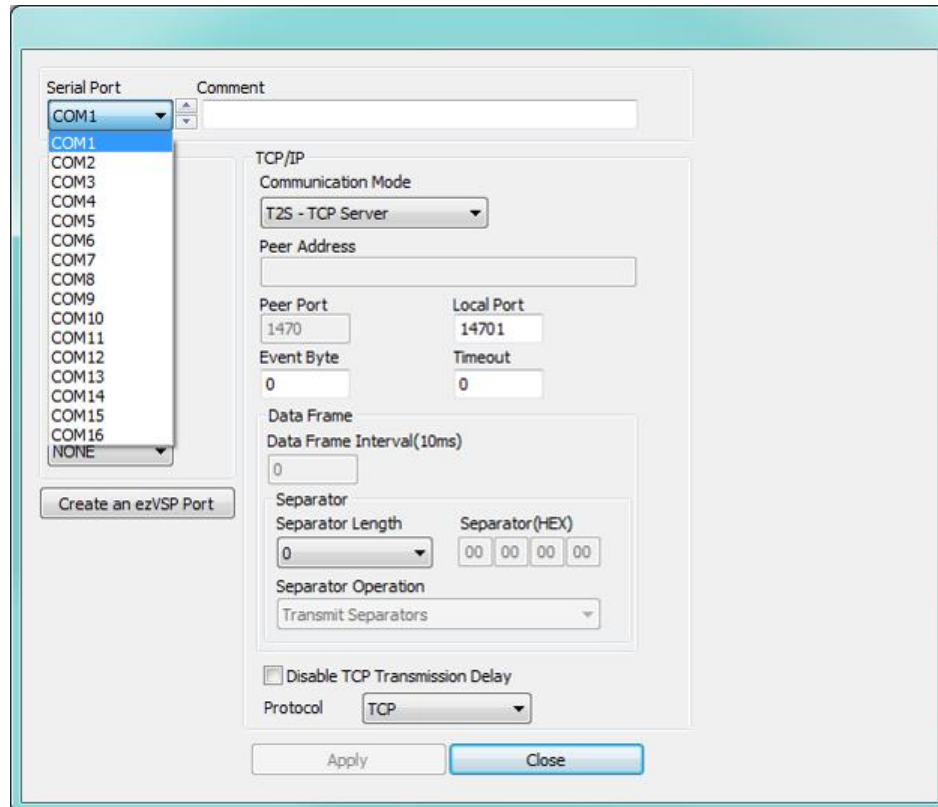

Figure 3-3 A port settings

You can set each port when you double-click a COM port in CSE-T16 tab.

Individual port setting is also available by opening a serial port list like in the Figure 3-3.

When you click [Write] button, all the modified settings are saved, and the product reboots, whereas [Apply] button in the individual port setting page will only save the settings without rebooting the product. (TCP Communication that was previously made will be disconnected.)

3.2 Initial Setup by using Console

You can perform initial settings for some items using the product console. Refer to section 5.2.2 for more details.

4 Communication mode

4.1 Normal Communication Mode

There are 3 types of connection to communicate with a remote host.

Mode	Protocol	Connection	Topology
TCP Server	TCP	Passive	1:1
TCP Client		Active	1:1
UDP	UDP	-	N:M

Tabl-4-1 comparison of communication mode

TCP protocol requires connection process. The connection is always established as 1:1 connection. At this time, the host waiting for connection (passive connection) is called a server and the one attempting to connect (active connection) is called a client.

On the other hand, UDP communicates by block unit without connection process. As UDP does not require connection, numbers of hosts can communicate at the same time.

4.2 TCP Server

In this mode, CSE-T16 listens to a TCP connection request from remote hosts. Once a host tries connecting to CSE-T16, it accepts a connection. After the connection is established, CSE-T16 converts the raw data from the serial port to TCP/IP data and sends it to the network and vice versa.

4.2.1 Key parameters

- Local Port

This is a server's port number which is used in the TCP connection.

- Event Byte

With setting event bytes, you can handle the serial data of the serial buffer before a TCP connection is established.

Value	Description
0	CSE-T16 does not send the data received before a TCP connection is established
Otherwise (512 or under)	CSE-T16 sends the data, which is received before a TCP connection is established, right after a connection is established. 512 or under bytes are strongly recommended.

Table 4-2 Event Byte

- Timeout

If there is no transmission data for amount of the time (in seconds) CSE-T16 actively close the connection. If this value is set to zero, the connection would not be terminated unless other side actively closes or there is an error on TCP connection.

4.2.2 Examples

- A situation that [Event Byte] is set to 0.

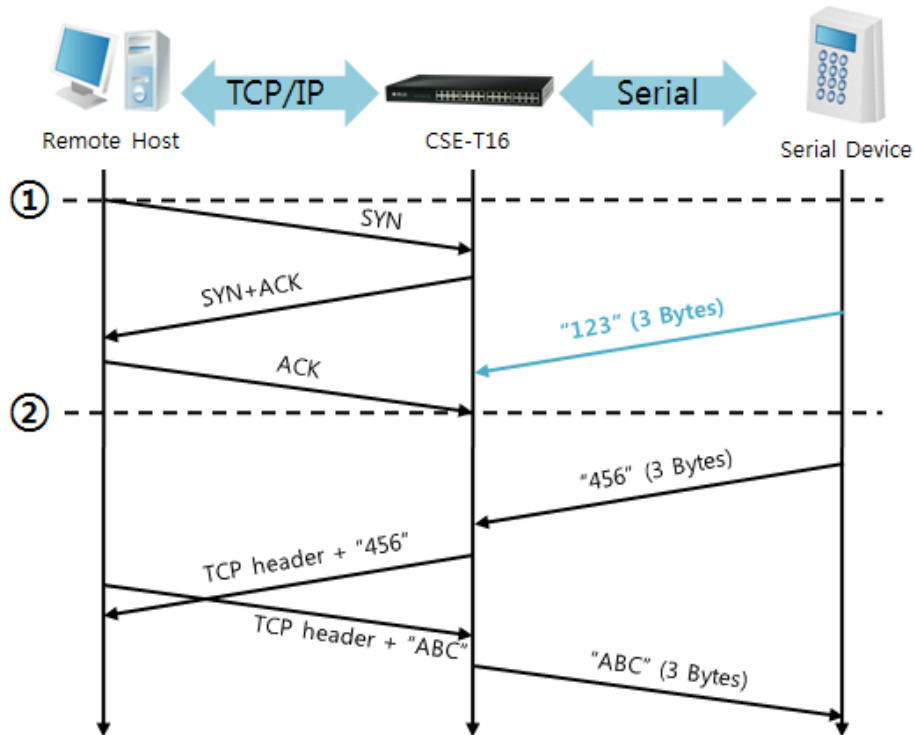

Figure 4-1 time chart

Time	States
~	CSE-T16 listens to connection requests
①	Remote host sends a connection request (SYN) segment
~	Processes of the connection
②	The connection is established
~	Data communication is implemented on both sides

Table 4-3 states of each point

Look at the blue arrow. The data "123" from the serial port has been received before establishing a connection. In this case, the data would not be sent because of the [Event Byte] is set to 0.

- A situation that [Event Byte] is set to 1.

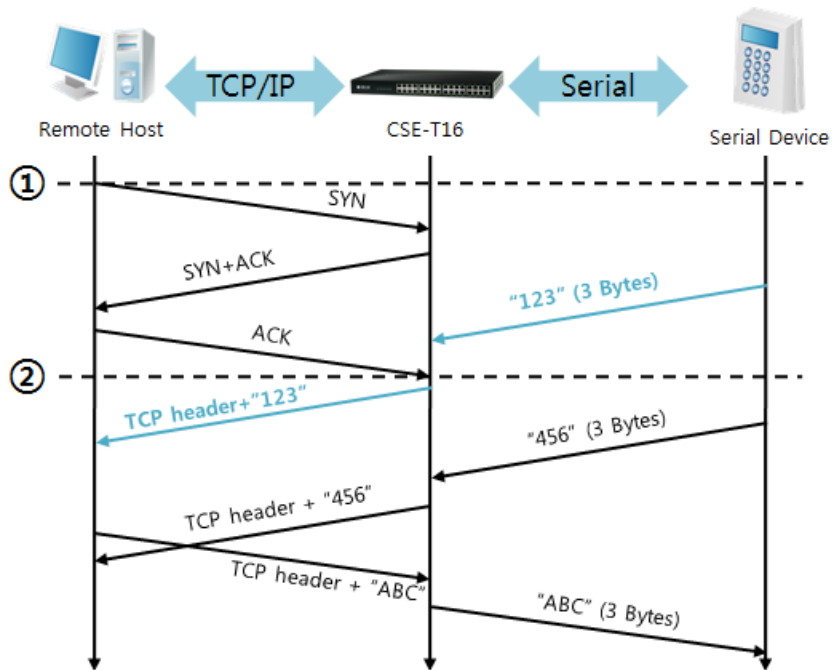

Figure 4-2 time chart

Time	States
~	CSE-T16 listens connection requests
①	Remote host sends connection request (SYN) segment
~	Processes of the connection
②	The connection is established
~	Data communication is implemented on both sides

Table 4-4 states of each point

As you can see, even though the data "123" arrives CSE-T16 before connection is established, it is sent to remote host right after establishing a connection because the value of [Event Byte] had been set to 1.

4.3 TCP Client

In this mode, CSE-T16 sends request segments to a TCP server with information of [Peer Address] and [Peer Port]. Once a host is listening, the connection will be established. After then, CSE-T16 converts the raw data from the serial port to TCP/IP data and sends them to the network and vice versa.

4.3.1 Key parameters

- Peer Address

This part is to put an IP address or a host name of TCP server.

- Peer Port

[Peer Port] is a port number of TCP server.

- Event Byte

In TCP Client mode, this parameter has two functions.

Firstly, this item can decide the point of time to send the connection request parameter.

Value	The point of time to send SYN request segment
0	Right after CSE-T16 boots up
Otherwise, N (N <= 512)	Right after CSE-T16 received N bytes from the serial port. Setting to less than 512 bytes is strongly recommended.

Table 4-5 the operation of Event Byte 1

Secondly, you can handle the serial data before a TCP connection is established with this parameter.

Value	Description
0	CSE-T16 does not send the data received before a TCP connection is established.
Otherwise (512 or under)	CSE-T16 sends the data, which is received before a TCP connection is established, right after a connection is established. Setting to less than 512 bytes is strongly recommended.

Table 4-6 the operation of Event Byte 2

- Timeout

If there is no transmission data for amount of the time (in seconds) CSE-T16 actively close the connection. If this value is set to zero, the connection would not be terminated unless other side actively closes or there is an error on TCP connection.

4.3.2 Examples

- A situation that [Event Byte] is set to 0

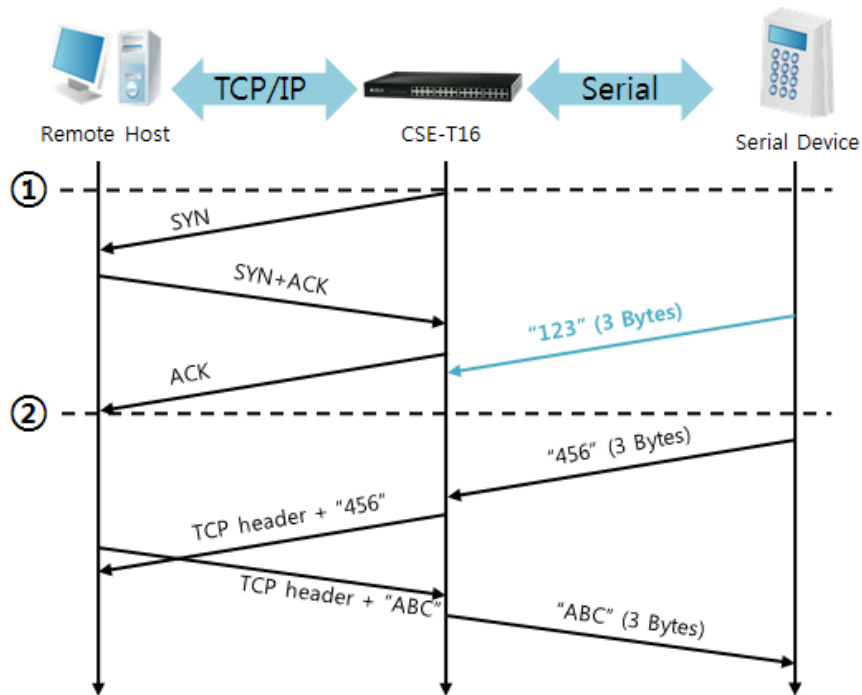

Figure 4-3 time chart

Time	States
~	Power is not supplied yet.
①	CSE-T16 sends a connection request segment right after it boots up.
~	processes of TCP connection
②	The connection is established.
~	data communication on both sides

Table 4-7 states of each point

Look at the blue arrow. The data "123" from the serial port was received from serial port before establishing a connection. In this case, the data would not be sent because the [Event Byte] is set to 0.

- A situation that [Event Byte] is set to 5

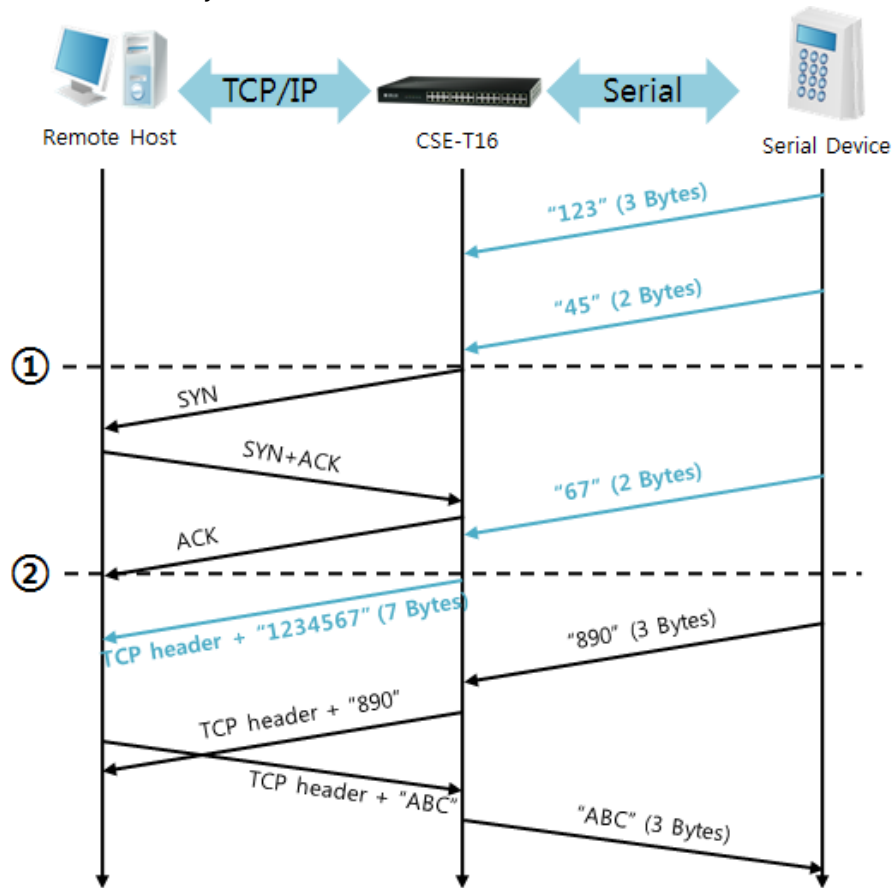

Figure 4-4 time chart

Time	States
~	CSE-T16 receives data from its serial port
①	CSE-T16 sends a connection request segment right after receiving 5 bytes
~	Processes of the TCP connection
②	The connection is established
~	The data "1234567" is transmitted to the remote host

Table 4-8 states of each point

As you can see, CSE-T16 has sent a request segment right after the size of the serial data has been 5 bytes. Even though they arrived before the connection, the data "123", "45" and "67" was transmitted to the remote host because the [Event Byte] is set to 5.

4.4 UDP

UDP has no connection processes. In this mode, data is sent in block units. Therefore, data that comes through CSE-T16's serial port is collected in block units to send it elsewhere.

4.4.1 Key parameters

- Block Size

[Block Size] is to set how many bytes of data need to in one block. If the number of bytes arrives come into the serial port reaches the block size value, CSE-T16 will send them as one block to the network. The maximum value could be 1460 bytes.

- Dynamic update of Peer host

If you set the value of [Peer Address] and [Peer Port] to 0, [dynamic update of peer host] function is activated. By using this function, CSE-T16 can automatically change the host, allowing to communicate with multiple hosts without additional setting.

4.4.2 Examples

- Block size: 5 Bytes

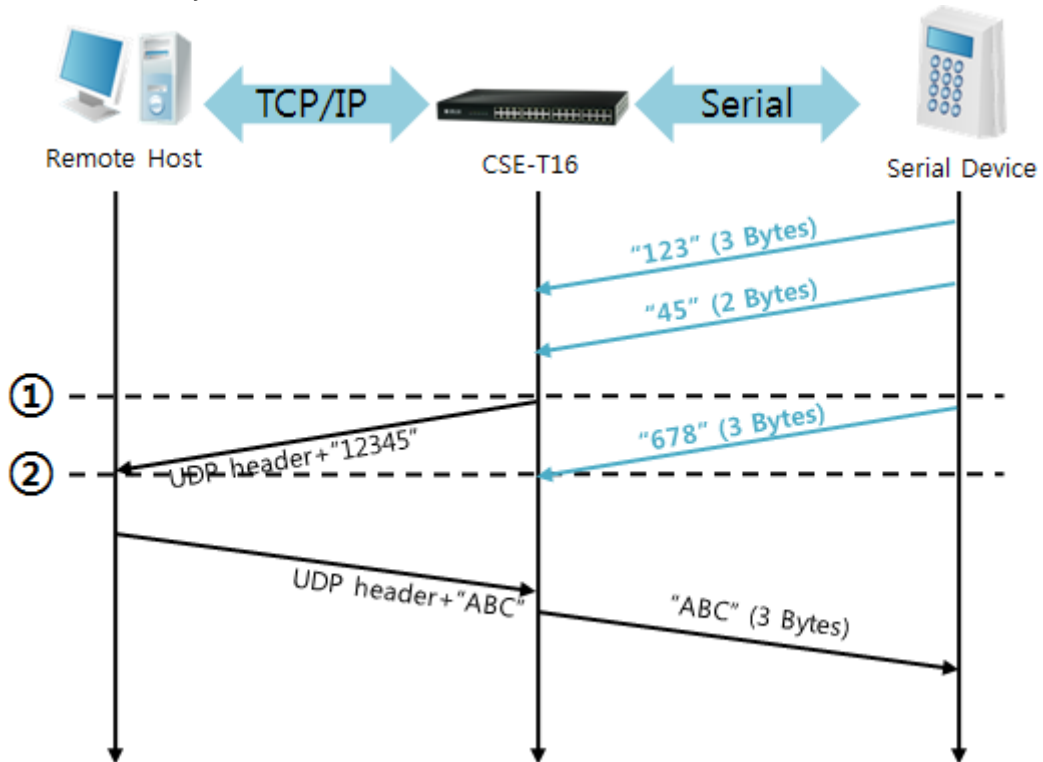

Figure 4-5 time chart

Time	States
~	CSE-T16 receives data from the serial port
①	CSE-T16 sends 5 bytes as one block based on the [Block Size]
~	Serial device sends the data "678"
②	The data "678" arrives.
~	Waiting data from the serial port to be 5 bytes.

Table 4-9 states of each point

Although CSE-T16 received data "678" from serial port it does not immediately send this data because it has not gathered enough block size of data. It keeps this data and waits for enough 5 bytes.

- Dynamic Update of Peer host

This is a function that CSE-T16 automatically sets its peer host with information of the last packet received from network. The source address of the packet is set to the peer host.

Parameters	Values
Peer Address	0 (None)
Peer Port	0

Table 4-10 setting for [dynamic update of peer host] function

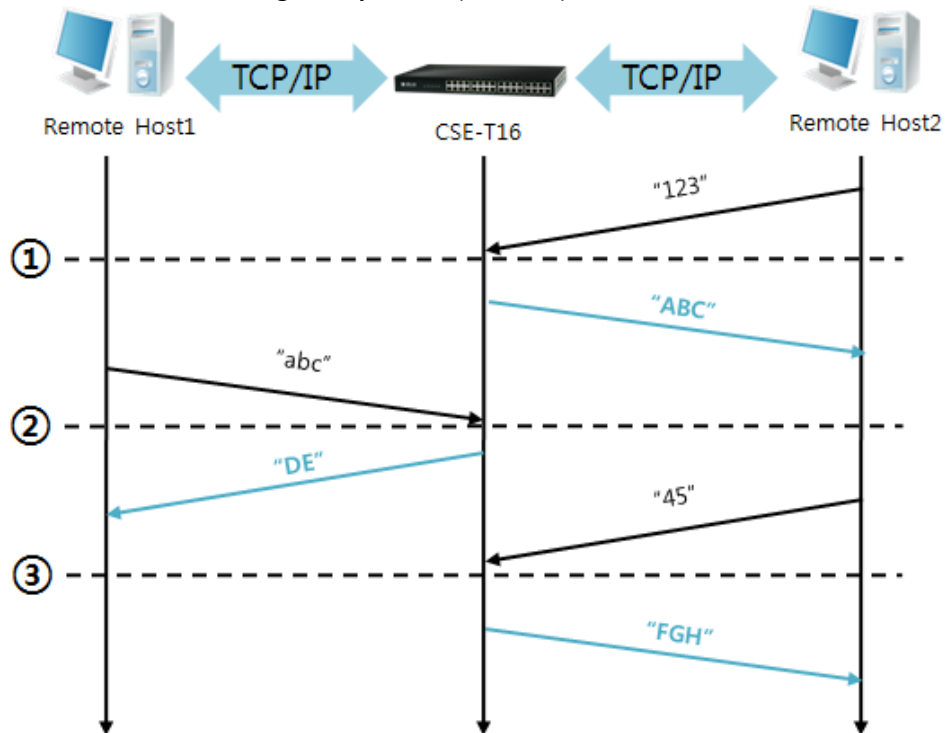

Figure 4-6 time chart

Time	States
~	Sending any UDP data to the network is impossible.
①	UDP data arrives from Remote Host 2.
~	Send UDP data to Remote Host 2.
②	UDP data arrives from Remote Host 1.
~	Send UDP data to Remote Host 1.
③	UDP data arrives from Remote Host 2.
~	Send UDP data to Remote Host 2.

Table 4-11 states of each point

☞ *The data "ABC", "DE" and "FGH" are ones that come from the serial port of CSE-T16 in the above figure.*

5 System Management

5.1 Upgrading Firmware

5.1.1 Firmware

Firmware is a type of software for operation of CSE-T16. If it is needed to add function or fix bugs, the firmware will be modified and released. We recommend that users keep using the latest released firmware.

5.1.2 Process

- Downloading the latest released firmware
Download the newest firmware file. We update our homepage when a new firmware is released. You can find it on our website.
- Run a TFTP client and ready to send the firmware file
Run a TFTP client program. ezManager is equipped with the client program.

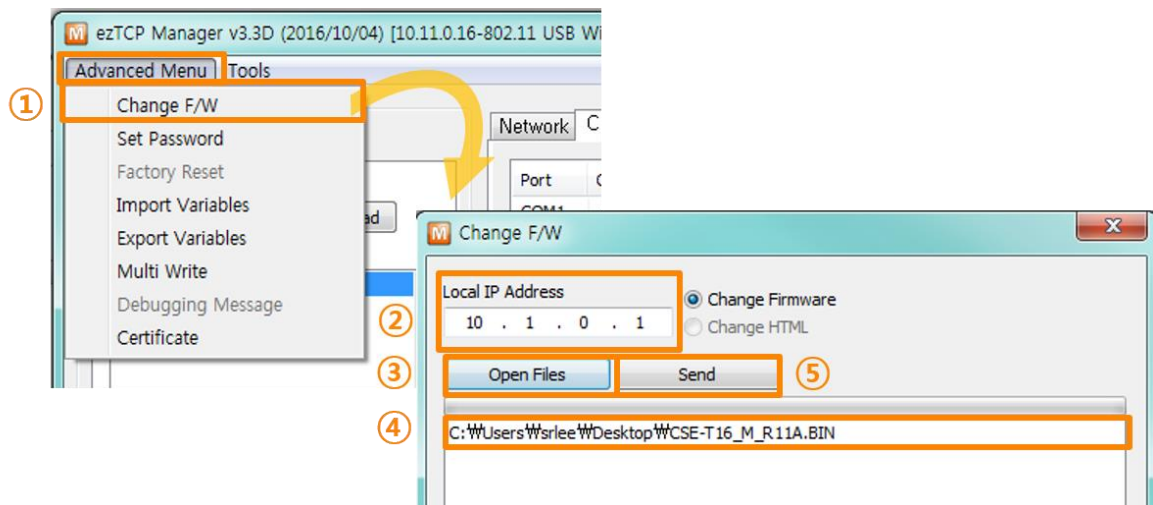

Figure 5-1 running TFTP client

- ① Click the [Change F/W] button to run TFTP client
- ② Input the IP address of CSE-T16 to the [Local IP Address] text box
- ③ Press the [Open Files] button and choose the firmware file
- ④ Check if the name and path of the firmware file are correct
- ⑤ Click the [Send] button

⑥ Input Password

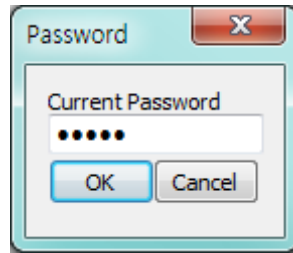

Figure 5-2 password

☞ **Default password is "sollae". (Firmware on V1.1 and before versions is "admin".)**

⑦ Confirm the completed message

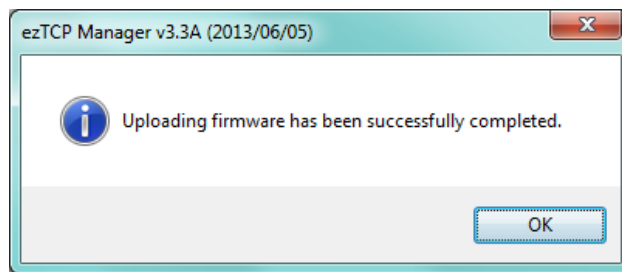

Figure 5-3 sending firmware file

5.2 Status Monitoring through Shell command

5.2.1 How to connect

- Console Port

You can access the Shell without the login process by connecting the product's console port to your PC's serial port and using a terminal program. The communication speed of this port is 115,200 bps.

- Telnet login

Once the [TELNET] option is activated, users can remotely log in to CSE-T16. If a password is set, users should input the password.

After that, messages from CSE-T16 appear as shown in the figure below.

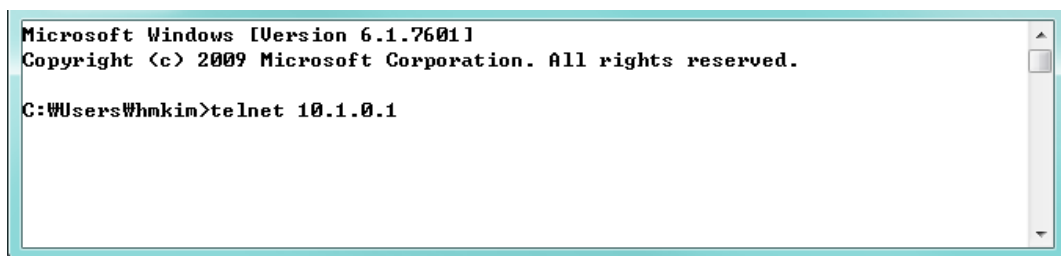

```
Microsoft Windows [Version 6.1.7601]
Copyright (c) 2009 Microsoft Corporation. All rights reserved.

C:\Users\whmkin>telnet 10.1.0.1
```

Figure 5-4 connect to CSE-T16

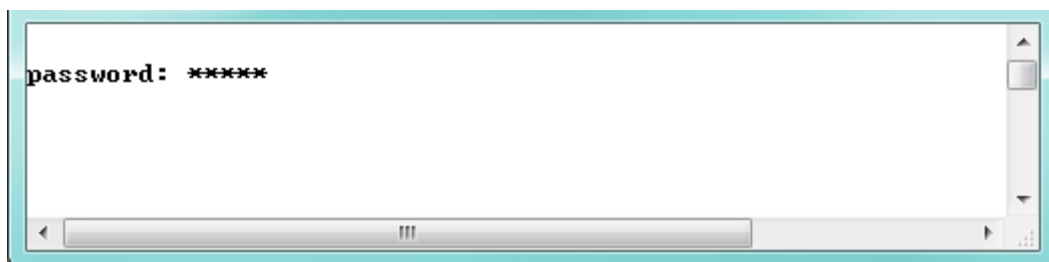

```
password: *****
```

Figure 5-5 Input password

☞ **Default password is "sollae"**

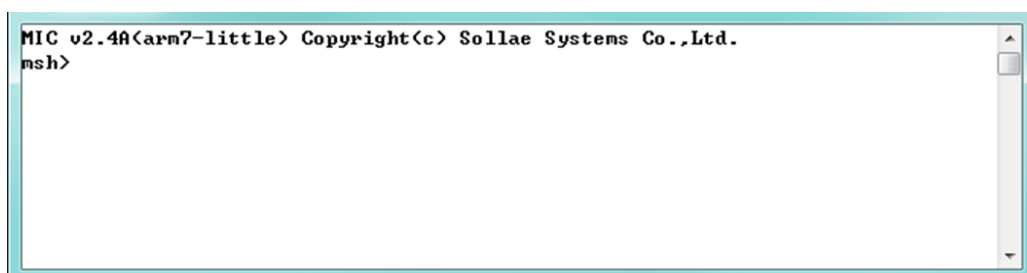

```
MIC v2.4A(arn7-little) Copyright(c) Sollae Systems Co.,Ltd.
msh>
```

Figure 5-6 log in

- SSH

When [SSH] option is activated on the ezManager, users can establish SSH secured connection to check equipment's serial and its network status. Following steps are to establish the SSH connection.

☞ **SSH function is available on firmware version of 1.1A or higher.**

① Click the [SSH] check box on the ezManager.

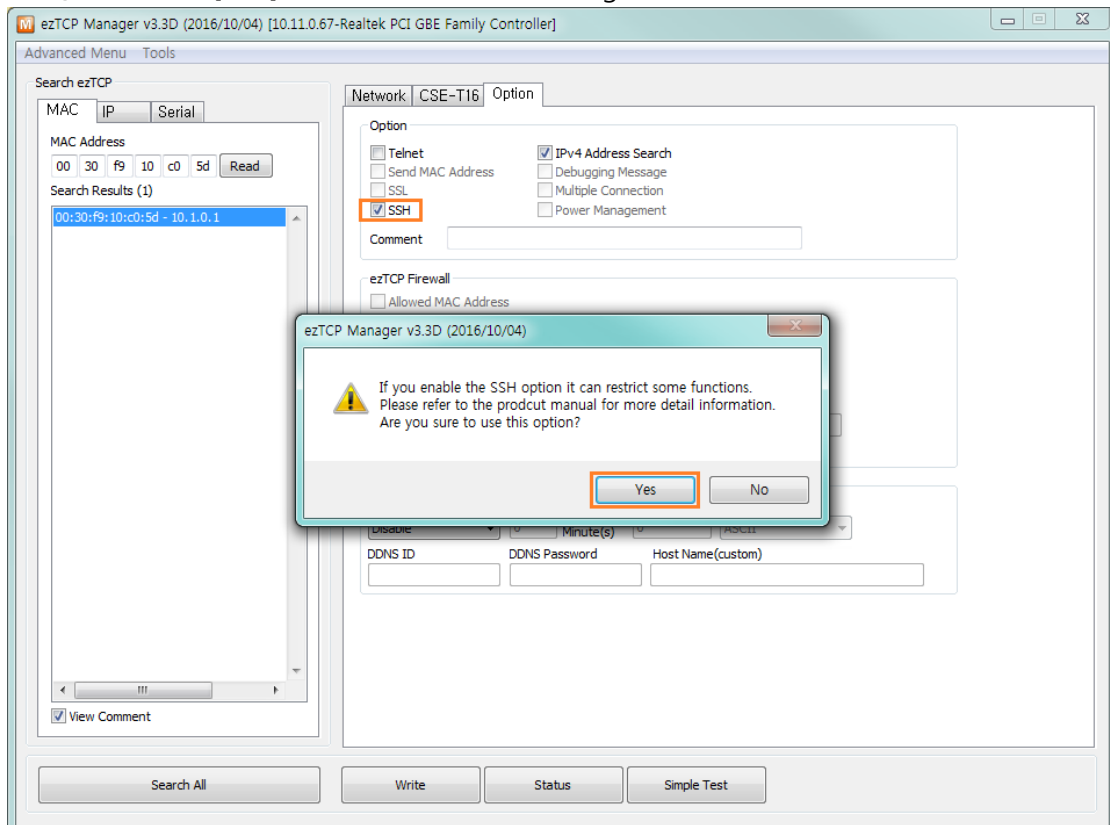

Figure 5-7 Set [SSH] option

☞ **You cannot use [Telnet] and [SSH] at the same time.**

② Make a certification and write it using ezManager (Refer to the Figure6-2 ~ Figure6-5)

☞ **Certification for SSH is available on ezManager of v3.3D or higher.**

③ Run the client program [PuTTY] that supports SSH and connect to port 22 (SSH default number). Try access and enter the ID and password. You will be able to connect as shown in the Figure 5-11 below.

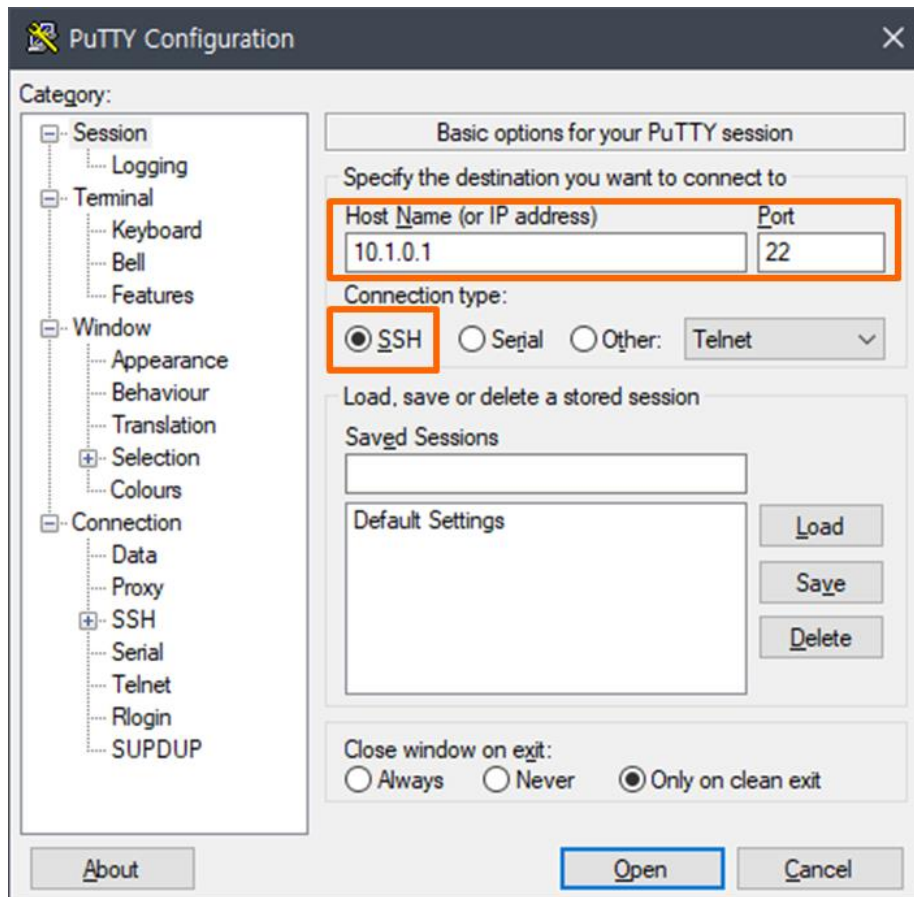

Figure 5-8 PuTTY(SSH Client program)

When user connect to CSE-H16 which is enabled "SSH" feature, pop up window like the below may appear.

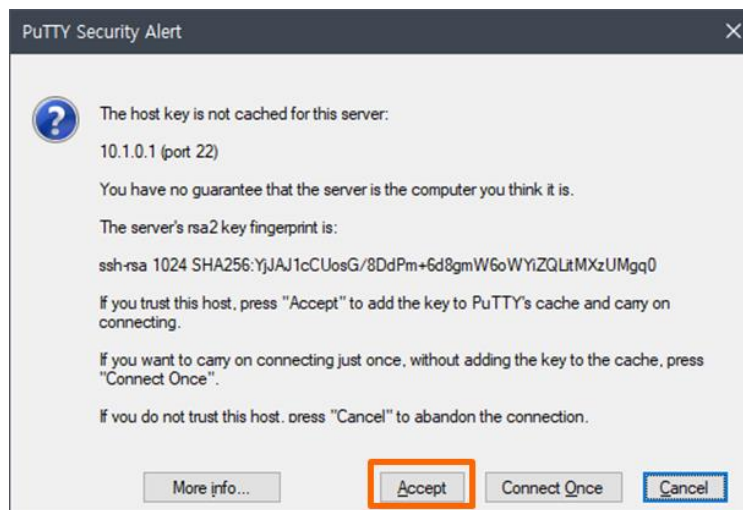

Figure 5-9 Check KEY value of SSH Server

If the SSH server's key is not cached in SSH client, the SSH client ask whether it save the server's key. After saving the server's key once, the SSH client doesn't ask this pop-up again. If user change the key of CSE-T16, the SSH client will ask it again.



Figure 5-10 Enter ID/Password

- ☞ *The default username and password for SSH access are [admin/sollae] for version v1.1A and [eztcp/sollae] for version v1.1B and later.*

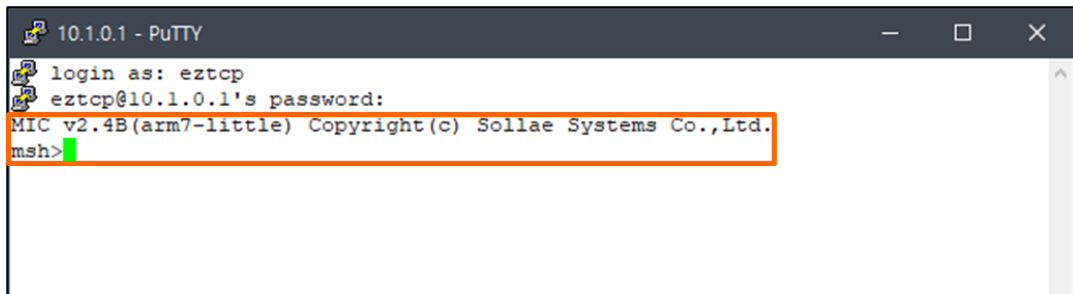
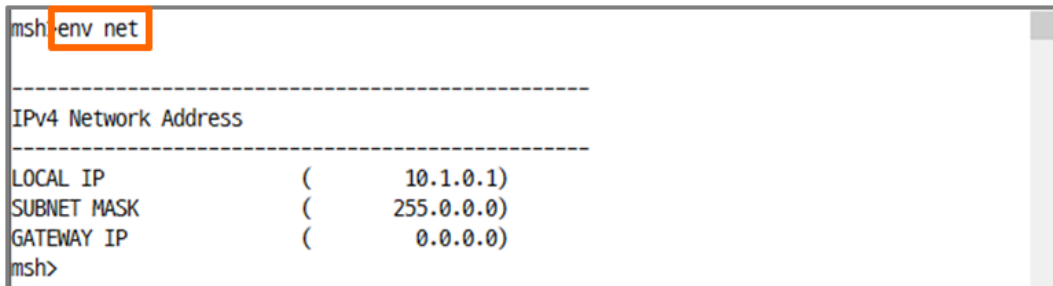

Figure 5-11 Completed SSH connection

5.2.2 Shell Commands for Initial Setup

- "env net" Command

This is the command to set the product's IP address, subnet mask, and gateway IP address.



```
msh>env net
-----
IPv4 Network Address
-----
LOCAL IP      (      10.1.0.1)
SUBNET MASK   (      255.0.0.0)
GATEWAY IP    (      0.0.0.0)
msh>
```

Figure 5-12 "env net" command

- "env cmt" Command

The command to set the product description for device identification.

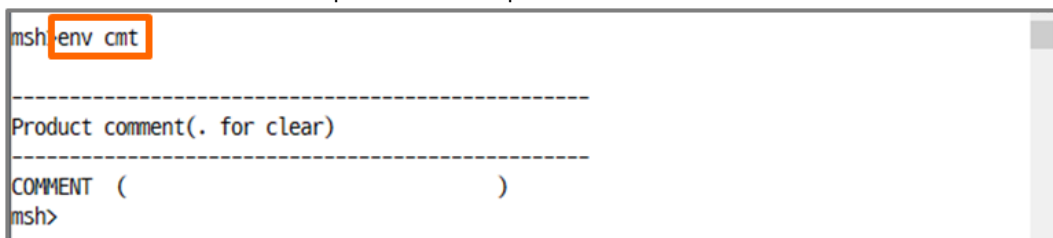

```
msh>env cmt
-----
Product comment(. for clear)
-----
COMMENT (      )
msh>
```

Figure 5-13 "env cmt" command

☞ *The initial setup commands can be used on firmware version 1.1B or later.*

☞ *When changing settings through the commands, the device will reboot.*

5.2.3 Shell Commands for Monitoring Status

- st uptime

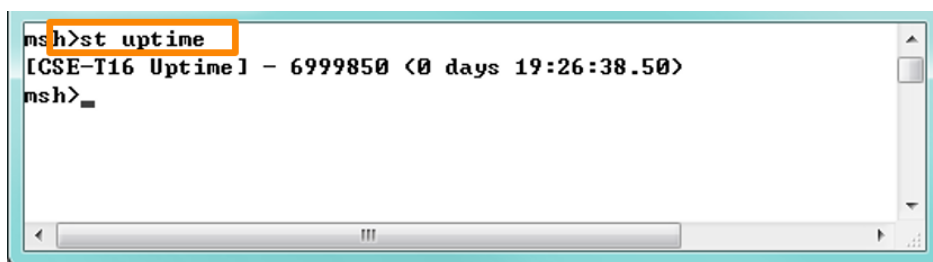

```
msh>st uptime
[ICSE-T16 Uptime] - 6999850 <0 days 19:26:38.50>
msh>
```

Figure 5-14 "st uptime" command

- **st net**

This command displays current Ipv4 network states of all sessions.

```

MIC-02-40/ans7-little> Copyright(c) Sollae Systems Co.,Ltd.
msh>st net
[TCP/UDP network connections / states ]
-----
local address      peer address  sendq  recvq      state      task
-----
TCP      10.1.0.1< 23>    10.7.0.57<52585> 215      0 ESTABLISHED
TCP      0.0.0.0<14716>   0.0.0.0< 0>      N/A      N/A      LISTEN
TCP      0.0.0.0<14713>   0.0.0.0< 0>      N/A      N/A      LISTEN
TCP      0.0.0.0<14715>   0.0.0.0< 0>      N/A      N/A      LISTEN
TCP      0.0.0.0<14711>   0.0.0.0< 0>      N/A      N/A      LISTEN
TCP      0.0.0.0<14709>   0.0.0.0< 0>      N/A      N/A      LISTEN
TCP      0.0.0.0<14714>   0.0.0.0< 0>      N/A      N/A      LISTEN
TCP      0.0.0.0<14712>   0.0.0.0< 0>      N/A      N/A      LISTEN
TCP      0.0.0.0<14710>   0.0.0.0< 0>      N/A      N/A      LISTEN
TCP      0.0.0.0<14707>   0.0.0.0< 0>      N/A      N/A      LISTEN
TCP      0.0.0.0<14706>   0.0.0.0< 0>      N/A      N/A      LISTEN
TCP      0.0.0.0<14704>   0.0.0.0< 0>      N/A      N/A      LISTEN
TCP      0.0.0.0<14703>   0.0.0.0< 0>      N/A      N/A      LISTEN
TCP      0.0.0.0<14708>   0.0.0.0< 0>      N/A      N/A      LISTEN
TCP      0.0.0.0<14705>   0.0.0.0< 0>      N/A      N/A      LISTEN
TCP      0.0.0.0<14701>   0.0.0.0< 0>      N/A      N/A      LISTEN
TCP      0.0.0.0<14702>   0.0.0.0< 0>      N/A      N/A      LISTEN
TCP      0.0.0.0< 22>     0.0.0.0< 0>      N/A      N/A      LISTEN      ssh
TCP      0.0.0.0< 23>     0.0.0.0< 0>      N/A      N/A      LISTEN      telnet
UDP      0.0.0.0<50007>   0.0.0.0< 0>      N/A      N/A      N/A      ezcfg
-----
[network interface]
-----
eth0  inet  ea-00:30:f9:00:00:08 ip-10.1.0.1 sm-255.0.0.0 UP rxq-1
-----
msh>

```

Figure 5-15 "st net" command

- **st sio**

This command displays the number of bytes of the serial port. (rx_bytes, tx_bytes)

```

msh>st sio
[CSE-116/32/48 usbsio information]
port rxbuf txbuf      rx_bytes      tx_bytes  berr ferr perr oerr
-----
1      0      0           0             0         0    0    0    0    0 RTS
2      0      0           0             0         0    0    0    0    0 RTS
3      0      0           0             0         0    0    0    0    0 RTS
4      0      0           0             0         0    0    0    0    0 RTS
5      0      0           0             0         0    0    0    0    0 RTS
6      0      0           0             0         0    0    0    0    0 RTS
7      0      0           0             0         0    0    0    0    0 RTS
8      0      0           0             0         0    0    0    0    0 RTS
9      0      0           0             0         0    0    0    0    0 RTS
10     0      0           0             0         0    0    0    0    0 RTS
11     0      0           0             0         0    0    0    0    0 RTS
12     0      0           0             0         0    0    0    0    0 RTS
13     0      0           0             0         0    0    0    0    0 RTS
14     0      0           0             0         0    0    0    0    0 RTS
15     0      0           0             0         0    0    0    0    0 RTS
16     0      0           0             0         0    0    0    0    0 RTS
-----
msh>

```

Figure 5-16 "st sio" command

5.3 Status Window of ezManager

5.3.1 Status

Status of CSE-T16 can be monitored by the [Status] button on ezManager. By using the [Refresh Every 1 Second] option in the window, the status will be automatically updated in every second.

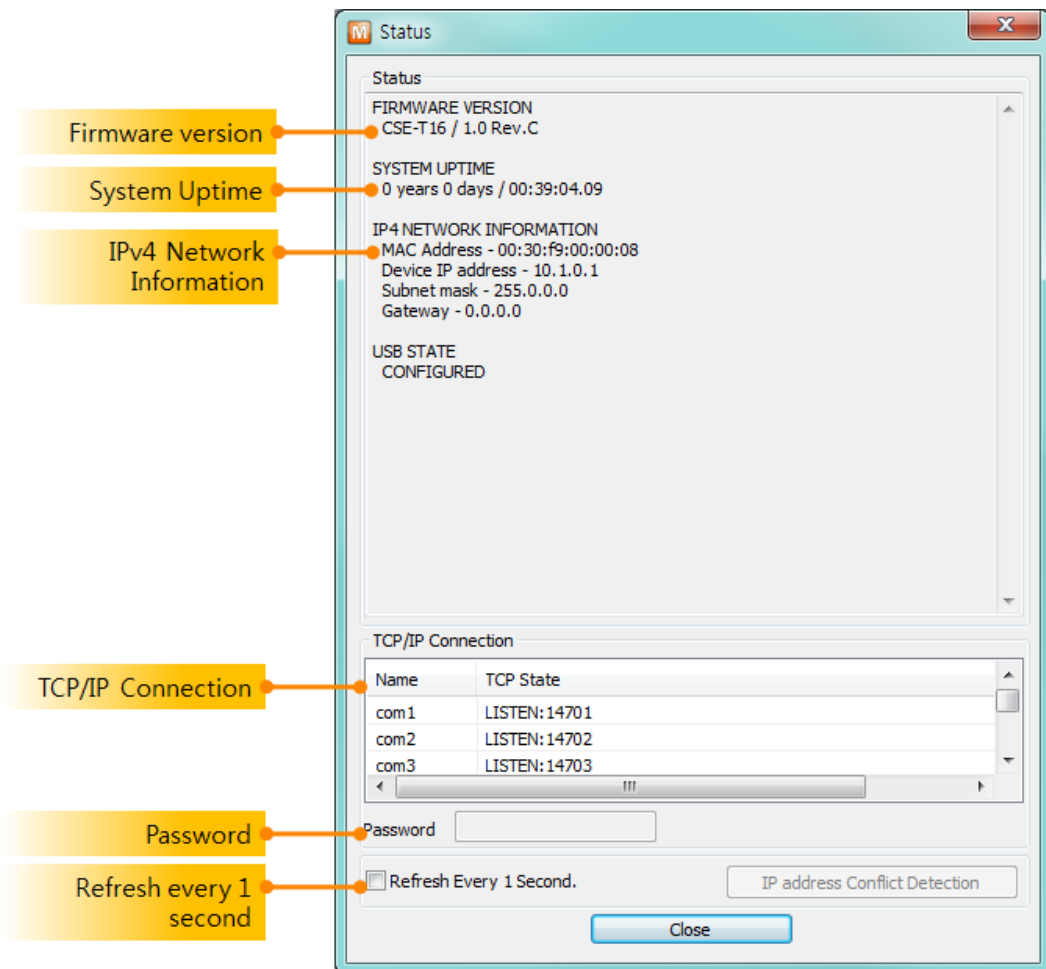

Figure 5-17 Status

- **FIRMWARE VERSION**
The name of model and the version of firmware are displayed here.
- **SYSTEM UPTIME**
Amount of operating time since CSE-T16 has booted up is displayed.
- **IP4 NETWORK INFORMATION**
All information about related items with the Ipv4 Address is shown here.
- **TCP/IP Connection**
The same information with [TCP STATE] is displayed with an IP address and port number. A

difference from [TCP STATE] is whether you can terminate TCP connection or not. When right click on a session, a small window will be popped up.

- Password

This text box is activated when CSE-T16 has a password. If you want to close TCP connection on [TCP/IP Connection] list, input the password first.

- Refresh Every 1 Second.

If this option is checked, ezManager sends queries in every second.

5.4 Factory Reset

It is a function physically initializes all the setting.

5.4.1 How to reset

Press FUNCTION button on the back of CSE-T16 for about 10 seconds to do a factory reset.

5.4.2 Sequence of LED operation

- STS1 On



- STS2 On



- LAN1 On



- LAN2 On



- STS1, STS2, LAN1, LAN2 are blinking



6 Security functions

6.1 SSL

6.1.1 SSL(Secure Socket Layer)

SSL is cryptographic protocol that provides secure communication on the Internet. SSL works over TCP.

6.1.2 How to set SSL

To set SSL, you have to set the SSL-related parameters as the following steps.
Select [TCP+SSL] of [Protocol] in [CSE-T16] tab of ezManager.

The screenshot shows the configuration window for CSE-T16. The 'Serial Port' section is on the left, with 'COM1' selected. The 'TCP/IP' section is on the right, with 'T2S - TCP Server' selected. The 'Peer Port' is 1470 and the 'Local Port' is 14701. The 'Event Byte' is 0 and the 'Timeout' is 0. The 'Data Frame Interval(10ms)' is 0. The 'Separator Length' is 0 and the 'Separator(HEX)' is 00 00 00 00. The 'Separator Operation' is 'Transmit Separators'. The 'Disable TCP Transmission Delay' checkbox is unchecked. The 'Protocol' dropdown menu is highlighted with an orange box and set to 'TCP+SSL'. The 'Apply' and 'Close' buttons are at the bottom.

Figure 6-1 SSL setting

- In case of T2S-TCP server mode, user make a certification and write it at CSE-T16. Please check the followings.

① Click the [Certificate] button in ezManager.

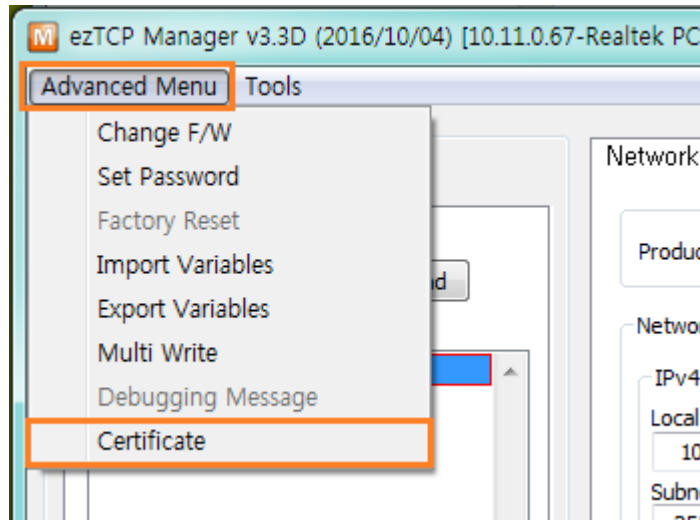

Figure 6-2 create the certification

② Choose the [Write self-signed certificate]

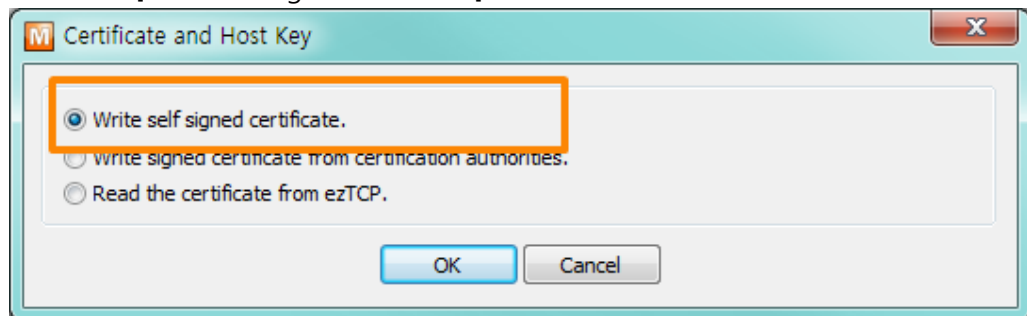
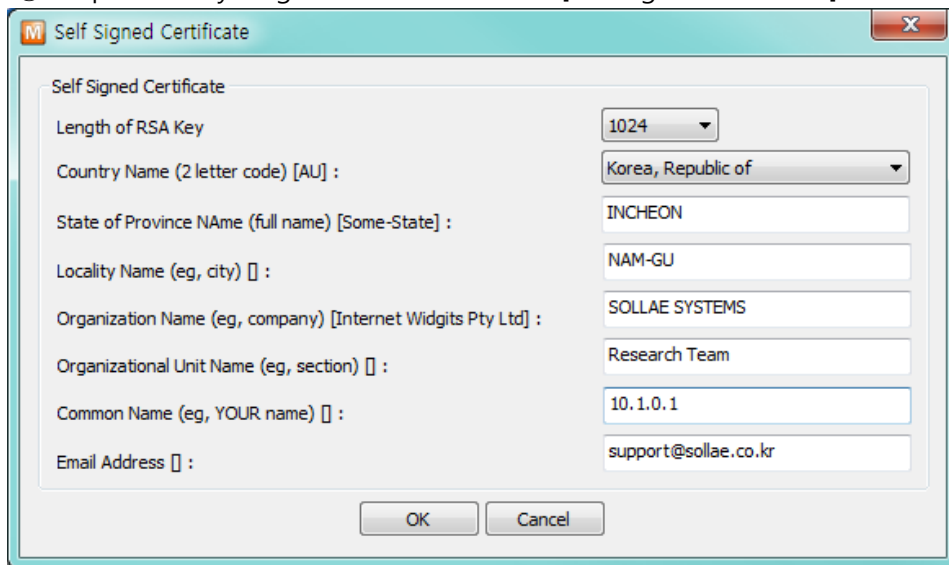

Figure 6-3 certificate and host key

- ③ Input the key length and information in [Self signed certificate]



Self Signed Certificate

Length of RSA Key: 1024

Country Name (2 letter code) [AU] : Korea, Republic of

State of Province Name (full name) [Some-State] : INCHEON

Locality Name (eg, city) [] : NAM-GU

Organization Name (eg, company) [Internet Widgits Pty Ltd] : SOLLAE SYSTEMS

Organizational Unit Name (eg, section) [] : Research Team

Common Name (eg, YOUR name) [] : 10.1.0.1

Email Address [] : support@sollae.co.kr

OK Cancel

Figure 6-4 input the information

- ④ Check the successful message

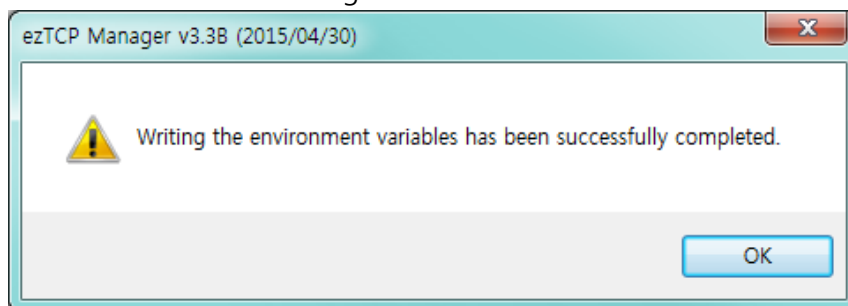

Figure 6-5 check the successful message

⑤ Check the certification

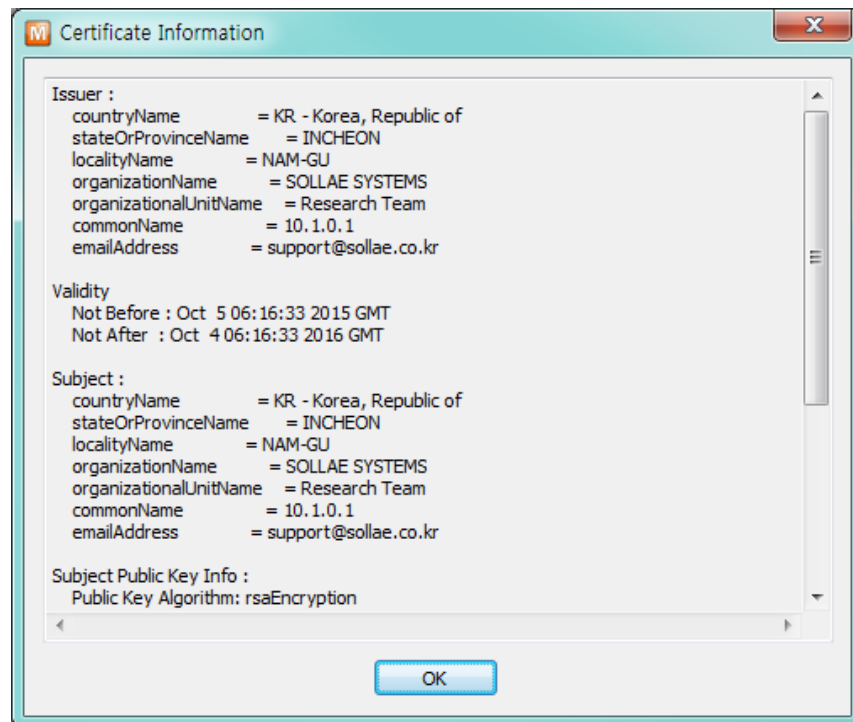

Figure 6-6 certification information

6.1.3 Restriction

You should generate a new certification when IP address changes. If user set SSL with CSE-T16, the other device have to set the SSL.

6.2 Setting password

A password can be used for protecting CSE-T16 from TELNET login or changing environmental parameters by unauthorized hosts. The maximum length is 8 bytes of Alphabet or number.

☞ If user forgets the password, factory reset must be done, and then all the environmental variables will be reset.

7 Additional Functions

7.1 CSE-T16 Tab Functions

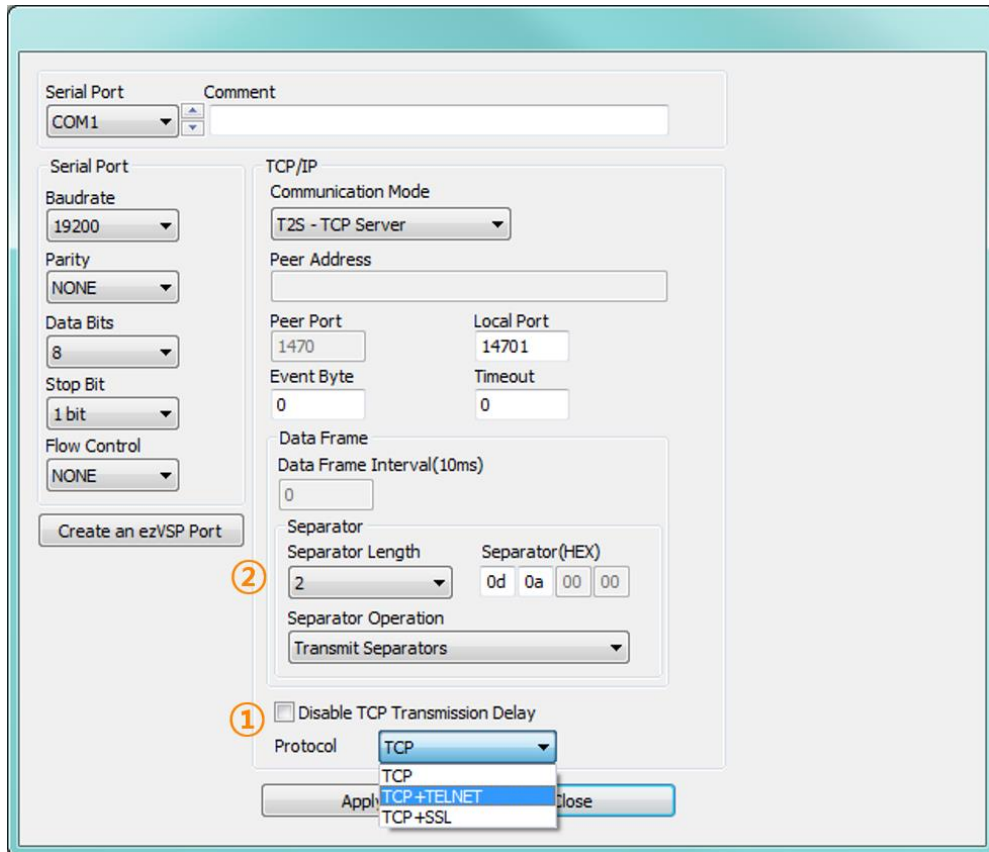

Figure 7-1 CSE-T16 tab

7.1.1 TCP+TENLET - ①

Using the TELNET option, user can use a universal telnet client program without developing a TCP/IP communication program.

- Sending serial break signal

You can send a break signal with a command "send brk" to serial port.

Type the command("send brk") using the escape shortcut keys (ctrl+]) after the TCP connection via telnet client.

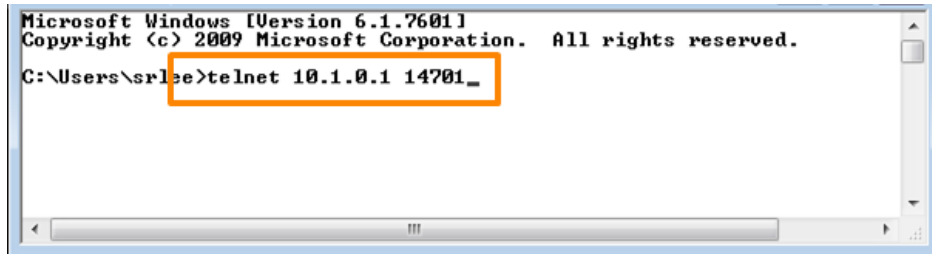

Figure 7-2 connecting telnet

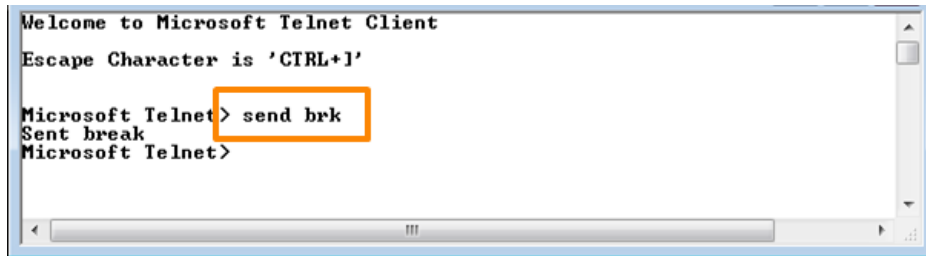

Figure 7-3 sending break signal

7.1.2 Separator - ②

Using this function, you can control the length of network packets by specific characters.

When you enable this function, the maximum packet size is 1024 bytes.

Separator	options
Length	select the length between 0 ~ 4 bytes
Operation	Transmit Separators without additional bytes
	Transmit Separators + 1 byte
	Transmit Separators + 2 bytes

Table 7-1 separator

7.1.3 Checking an option

Port	Comment	COM Port	TCP/IP	Option
COM1		19200-N-8-1-NF	[TCP Server] 14701	E, T, R, S
COM2		19200-N-8-1-NF	[TCP Server] 14702	
COM3		19200-N-8-1-NF	[TCP Server] 14703	
COM4		19200-N-8-1-NF	[TCP Server] 14704	
COM5		19200-N-8-1-NF	[TCP Server] 14705	
COM6		19200-N-8-1-NF	[TCP Server] 14706	
COM7		19200-N-8-1-NF	[TCP Server] 14707	

Figure 7-4 CSE-T16 ports option

You can check options of each port with alphabetical initials.

Initials	Option
E	Event Bytes
T	Time out
R	TCP + TELNET (RFC 2217)
S	Separator

Table 7-2 Initials for checking an option

7.2 Option tab functions

7.2.1 Notify Ipv4 Change

CSE-T16 can be a TCP server even though it is assigned an IP address automatically. Using [Notify IP Change] function, CSE-T16 sends its IP address with the host name to the designated server.

- Dynamic Domain Name Service (DDNS)
CSE-T16 supports DDNS service offered by DynDNS. Therefore, you have to make an account and create host names on the website of DynDNS before you use.

☞ **All about service usage of an account could be changed according to the policy of DynDNS.**

Figure 7-5 setting DDNS

- ① Select the [DDNS(dyndns.org)]
- ② 40,320 is a fixed value
- ③ Input the ID of DDNS account
- ④ Input the password of the account
- ⑤ Input a host name which you create on your account

☞ **Refer to the [IP Change Notification] document on our website for details.**

8 Technical Support and Warranty

8.1 Technical Support

If you have any question regarding operation of the product, visit Customer Support FAQ corner and the message board on Sollae Systems' web site or send us an email at the following address:

- E-mail: support@eztcp.com
- Website Address for Customer Support: <https://www.eztcp.com/en/support/>

8.2 Warranty

8.2.1 Refund

Upon the customer's request to refund the product within two weeks after purchase, Sollae Systems will refund the product.

8.2.2 Free Repair Services

For product failures occurring within 2 years after purchase, Sollae Systems provides free repair services or exchange the product. However, if the product failure is due to user's fault, repair service fees will be charged or the product will be replaced at user's expense.

8.2.3 Charged Repair Services

For product failures occurring after the warranty period (2 years) or resulting from user's fault, repair service fees will be charged and the product will be replaced at user's expense.

9 Precaution and Exemption from Liability

9.1 Precaution

- Sollae Systems is not responsible for product failures occurring due to user's alteration of the product.
- Specifications of the product are subject to change without prior notice for performance improvement.
- Sollae Systems does not guarantee successful operation of the product if the product was used under conditions deviating from the product specifications.
- Reverse engineering of firmware and applications provided by Sollae Systems is prohibited.
- Use of firmware and applications provided by Sollae Systems for purposes other than those for which they were designed is prohibited.
- Do not use the product in an extremely cold or hot place or in a place where vibration is severe.
- Do not use the product in an environment in which humidity is high or a lot of oil exists.
- Do not use the product where there is caustic or combustible gas.
- Sollae Systems does not guarantee normal operation of the product under the conditions a lot of noise exists.
- Do not use the product for a purpose that requires exceptional quality and reliability relating to user's injuries or accidents – aerospace, aviation, health care, nuclear power, transportation, and safety purposes.
- Sollae Systems is not responsible for any accident or damage occurring while using the product.

9.2 Exemption from Liability

9.2.1 English version

In no event shall Sollae Systems Co., Ltd. and its distributors be liable for any damages whatsoever (including, without limitation, damages for loss of profit, operating cost for commercial interruption, loss of information, or any other financial loss) from the use or inability to use the CSE-T16 even if Sollae Systems Co., Ltd. or its distributors have been informed of such damages.

The CSE-T16 is not designed and not authorized for use in military applications, in nuclear applications, in airport applications or for use in applications involving explosives, or in medical applications, or for use in security alarm, or for use in a fire alarm, or in applications involving elevators, or in embedded applications in vehicles such as but not limited to cars, planes, trucks, boats, aircraft, helicopters, etc..

In the same way, the CSE-T16 is not designed, or intended, or authorized to test, develop, or be built into applications where failure could create a dangerous situation that may result in financial losses, damage to property, personal injury, or the death of people or animals. If you use the CSE-T16 voluntarily or involuntarily for such unauthorized applications, you agree to subtract Sollae Systems Co., Ltd. and its distributors from all liability for any claim for compensation.

Sollae Systems Co., Ltd. and its distributors entire liability and your exclusive remedy shall be Sollae Systems Co., Ltd. and its distributors option for the return of the price paid for, or repair, or replacement of the CSE-T16.

Sollae Systems Co., Ltd. and its distributors disclaim all other warranties, either expressed or implied, including, but not limited to, the implied warranties of merchantability and fitness for a particular purpose, with respect to the CSE-T16 including accompanying written material, hardware and firmware.

9.2.2 French version

- Documentation

La documentation du boîtier CSE-T16 est conçue avec la plus grande attention. Tous les efforts ont été mis en œuvre pour éviter les anomalies. Toutefois, nous ne pouvons garantir que cette documentation soit à 100% exempt de toute erreur. Les informations présentes dans cette documentation sont données à titre indicatif. Les caractéristiques techniques peuvent changer à tout moment sans aucun préavis dans le but d'améliorer la qualité et les possibilités des produits.

- Copyright et appellations commerciales

Toutes les marques, les procédés, les références et les appellations commerciales des produits cités dans la documentation appartiennent à leur propriétaire et Fabricant respectif.

- Conditions d'utilisations et limite de responsabilité

En aucun cas Sollae Systems Co., Ltd. ou un de ses distributeurs ne pourra être tenu responsable de dommages quels qu'ils soient (intégrant, mais sans limitation, les dommages pour perte de bénéfice commercial, interruption d'exploitation commerciale, perte d'informations et de données à caractère commercial ou de toute autre perte financière) provenant de l'utilisation ou de l'incapacité à pouvoir utiliser le boîtier CSE-T16, même si Sollae Systems Co., Ltd. ou un de ses distributeurs a été informé de la possibilité de tels dommages.

Le boîtier CSE-T16 est exclusivement prévu pour un usage en intérieur, dans un environnement sec et non poussiéreux. Le boîtier CSE-T16 n'est pas prévu, ni autorisé pour être utilisé en extérieur, ni de façon embarquée dans des engins mobiles de quelque nature que ce soit (voiture, camion, train, avion, etc...), ni en milieu explosif, ni dans des enceintes nucléaires, ni dans des ascenseurs, ni dans des aéroports, ni dans des enceintes hospitaliers, ni pour des applications à caractère médical, ni dans des dispositifs de détection et d'alerte anti-intrusion, ni dans des dispositifs de détection et d'alerte anti-incendie, ni dans des dispositifs d'alarme GTC, ni pour des applications militaires.

De même, le boîtier CSE-T16 n'est pas conçu, ni destiné, ni autorisé pour expérimenter, développer ou être intégré au sein d'applications dans lesquelles une défaillance de celui-ci pourrait créer une situation dangereuse pouvant entraîner des pertes financières, des dégâts matériels, des blessures corporelles ou la mort de personnes ou d'animaux. Si vous utilisez le boîtier CSE-T16 volontairement ou involontairement pour de telles applications non autorisées, vous vous engagez à soustraire Sollae Systems Co., Ltd. et ses distributeurs de toute responsabilité et de toute demande de dédommagement.

En cas de litige, l'entière responsabilité de Sollae Systems Co., Ltd. et de ses distributeurs vis-à-vis

de votre recours durant la période de garantie se limitera exclusivement selon le choix de Sollae Systems Co., Ltd. et de ses distributeurs au remboursement de votre produit ou de sa réparation ou de son échange. Sollae Systems Co., Ltd. et ses distributeurs démentent toutes autres garanties, exprimées ou implicites.

Tous les boîtiers CSE-T16 sont testés avant expédition. Toute utilisation en dehors des spécifications et limites indiquées dans cette documentation ainsi que les court-circuit, les chocs, les utilisations non autorisées, pourront affecter la fiabilité, créer des dysfonctionnements et/ou la destruction du boîtier CSE-T16 sans que la responsabilité de Sollae Systems Co., Ltd. et de ses distributeurs ne puissent être mise en cause, ni que le boîtier CSE-T16 puisse être échangé au titre de la garantie.

- Conditions d'utilisations et limite de responsabilité

En aucun cas Sollae Systems Co., Ltd. ou un de ses distributeurs ne pourra être tenu responsable de dommages quels qu'ils soient (intégrant, mais sans limitation, les dommages pour perte de bénéfice commercial, interruption d'exploitation commerciale, perte d'informations et de données à caractère commercial ou de toute autre perte financière) provenant de l'utilisation ou de l'incapacité à pouvoir utiliser le boîtier CSE-T16, même si Sollae Systems Co., Ltd. ou un de ses distributeurs a été informé de la possibilité de tels dommages.

10 Revision History

Date	Version	Description	Author
2015.10.12	1.0	○ Initial release	Amy Kim
2016.10.21	1.1	○ Add function of SSH ○ Add a description on 7.1.2. Separator	Sara Lee
2017.10.24	1.2	○ Add reference on 3.1.1	Sara Lee
2024.03.08.	1.3	○ Updated URL of websites ○ Removed the Components section ○ Removed the Related materials section ○ Added shell commands for initial setup ○ Modified contents about the default ID/PW of SSH ○ Removed the URL of DYN homepage ○ Improved and added contents about the console port ○ Added contents about the function button ○ Corrected some errors and improved expressions ○ Updated some figures	Roy Lee