

2Ports Serial Device Server

CSE-H20 User Manual

Version 2.9



Sollae Systems Co., Ltd.

<https://www.ezTCP.com>



This symbol, found on your product or on its packaging, indicates that this product should not be treated as household waste when you wish to dispose of it. Instead, it should be handed over to an applicable collection point for the recycling of electrical and electronic equipment. By ensuring this product is disposed of correctly, you will help prevent potential negative consequences to the environment and human health, which could otherwise be caused by inappropriate disposal of this product. The recycling of materials will help to conserve natural resources. For more detailed information about the recycling of this product, please contact your local city office, household waste disposal service or the retail store where you purchased this product.

※ This equipment obtained certification by using 1.5M serial cable.

Note:

This equipment has been tested and found to comply with the limits for a Class A digital device, pursuant to part 15 of the FCC Rules. These limits are designed to provide reasonable protection against harmful interference when the equipment is operated in a commercial environment. This equipment generates, uses, and can radiate radio frequency energy and, if not installed and used in accordance with the instruction manual, may cause harmful interference to radio communications. Operation of this equipment in a residential area is likely to cause harmful interference in which case the user will be required to correct the interference at his own expense.

Contents

Contents	- 2 -
1 Overview	- 5 -
1.1 Overview	- 5 -
2 Specifications	- 6 -
2.1 Specifications	- 6 -
2.2 Interface	- 7 -
2.2.1 Serial Ports (RJ45).....	- 7 -
2.2.2 Ethernet Interface.....	- 9 -
2.2.3 Power.....	- 9 -
2.2.4 System LEDs.....	- 10 -
2.2.5 ISP Switch.....	- 10 -
3 Installation and Test Run	- 11 -
3.1 Installation Method.....	- 11 -
3.1.1 Checking the Communication Environment.....	- 11 -
3.1.2 Connecting to the Network.....	- 12 -
3.1.3 Configuring the Environmental Variables.....	- 12 -
3.2 Test Run	- 12 -
3.2.1 Changing PC IP Address.....	- 12 -
3.2.2 Installing CSE-H20.....	- 12 -
3.2.3 Configuring CSE-H20.....	- 13 -
3.2.4 Communication Test.....	- 13 -
4 Configuring IP Address Variables	- 17 -
4.1 IP Address and Environmental Variables	- 17 -
4.2 Configuring with ezManager.....	- 17 -
4.2.1 ezManager.....	- 17 -
4.2.2 Buttons of ezManager.....	- 18 -
4.2.3 Parameters of ezManager.....	- 18 -
4.2.4 Matters to be attended to	- 19 -
4.3 AT command.....	- 20 -
4.4 Notify IP Change.....	- 20 -
4.4.1 DDNS (Dynamic Domain Name System).....	- 20 -
4.4.2 TCP/UDP.....	- 20 -
5 Operation Mode	- 21 -

5.1	Operation Mode Overview	- 21 -
5.1.1	Overview	- 21 -
5.2	How to Initiate Each Operation Mode	- 21 -
5.2.1	How to Initiate the Normal Mode	- 21 -
5.2.2	How to Initiate the Serial Configuration Mode	- 21 -
5.2.3	How to Initiate the ISP Mode	- 21 -
5.2.4	Comparison of Operation Modes	- 21 -
5.3	Normal Communication Mode	- 22 -
5.4	Serial Configuration Mode	- 22 -
5.5	ISP Mode	- 23 -
5.5.1	Upgrading Firmware	- 23 -
6	Normal Communication Mode	- 24 -
6.1	T2S – TCP Server	- 24 -
6.1.1	TCP Connection	- 24 -
6.1.2	Serial Data before the TCP Connection	- 24 -
6.1.3	Data Transmission	- 25 -
6.1.4	Disconnection	- 25 -
6.2	COD – TCP Client	- 26 -
6.2.1	Serial Data before the TCP Connection	- 26 -
6.2.2	Data Transmission	- 26 -
6.2.3	Disconnection	- 27 -
6.2.4	DNS	- 27 -
6.3	ATC – AT Command	- 28 -
6.3.1	Key parameters	- 28 -
6.3.2	Examples	- 29 -
6.4	UDP	- 32 -
6.4.1	Key parameters	- 32 -
6.4.2	Examples	- 33 -
7	Security Protocols & Option	- 35 -
7.1	SSL	- 35 -
7.1.1	SSL (Secure Socket Layer)	- 35 -
7.1.2	How to set the SSL on CSE-H20	- 35 -
7.1.3	Restriction	- 36 -
7.2	SSH	- 37 -
7.2.1	SSH (Secure Shell)	- 37 -
7.2.2	How to set the SSH on CSE-H20	- 37 -
7.2.3	Restriction	- 38 -

- 7.3 ezTCP Firewall - 39 -
- 8 Checking & Debugging..... - 40 -**
 - 8.1 Telnet - 40 -
 - 8.1.1 Telnet Login..... - 40 -
 - 8.1.2 Commands..... - 40 -
 - 8.2 Status on ezManager - 42 -
 - 8.2.1 Status of the CSE-H20..... - 42 -
 - 8.2.2 Closing TCP connection by the ezManager..... - 42 -
 - 8.3 Remote Debugging..... - 43 -
 - 8.4 Sending MAC Address..... - 43 -
- 9 Technical Support and Warranty..... - 44 -**
 - 9.1 Technical Support - 44 -
 - 9.2 Warranty..... - 44 -
 - 9.2.1 Refund..... - 44 -
 - 9.2.2 Free Repair Services - 44 -
 - 9.2.3 Charged Repair Services..... - 44 -
- 10 Precaution and Exemption from Liability - 45 -**
 - 10.1 Precaution..... - 45 -
 - 10.2 Exemption from Liability..... - 46 -
 - 10.2.1 English version - 46 -
 - 10.2.2 French version..... - 46 -
- 11 Revision History..... - 49 -**



1 Overview

1.1 Overview

Along with the development of the Internet, the demand for data communication functions has increased recently. Data communication over the Internet requires using TCP/IP, the Internet communication protocol. That is to say, in order to connect a system to the Internet, TCP/IP protocol must be implemented. It is possible to implement TCP/IP by directly implementing the protocol, porting public TCP/IP, or using Operating System (OS). However, all these methods impose burdens on the developer in time, cost, and technology.

ezTCP series, a Serial ↔ TCP/IP protocol converter product group of Sollae Systems, enables you to use TCP/IP communication (the Internet communication) function simply by "connecting the cable to a serial port". ezTCP sends data from the serial port to the Internet network after TCP/IP processing, and vice versa.

CSE-H20 in ezTCP product group is a product that provides TCP/IP communication through Ethernet. In other words, like other ezTCP products, CSE-H20 sends data from the serial port to the LAN after TCP/IP processing and vice versa.

As CSE-H20 has 2 RS232 ports, it can be connected to two RS232 devices in the same time. And it is easy CSE0-H20 to attach to user systems because of its compact size.

It provides DHCP and PPPoE functions, so that it can be applied to the cable network and the xDSL network. And it has DDNS (Dynamic DNS) function, so it can be used more easily in the internet.

It also provides debugging function, so user can solve the problem with ours.

2 Specifications

2.1 Specifications

Power	Input Voltage	5V ($\pm 10\%$)
	Current	200mA typical
Dimension	87mm x 57mm x 24mm	
Weight	About 70g	
Interface	Serial	RJ45 x 2
	Network	RJ45
Serial Port	2 x RS232 (300bps ~ 230400bps, RTS/CTS flow control)	
Network	Ethernet 10Base-T or 100Base-TX (Auto-Sensing) Auto MDI/MDIX	
Protocols	TCP, UDP, IP, ICMP, ARP, DHCP, PPPoE DNS lookup, Dynamic DNS(DDNS) Telnet COM Port Control Option (RFC2217) SSL, SSH	
Diagnostic	Online Debugging Function	
RoHS	RoHS Compliant	
Approvals	CE, FCC, MIC	
Communication Mode	T2S	TCP Server Mode
	COD	TCP Client Mode
	ATC	TCP Server/Client (AT command emulation)
	U2S	UDP
Utilities	ezManager	Configuration utility via LAN
	ezVSP	Serial-TCP/IP virtual driver for Windows

Table 2-1 specifications

2.2 Interface

2.2.1 Serial Ports (RJ45)

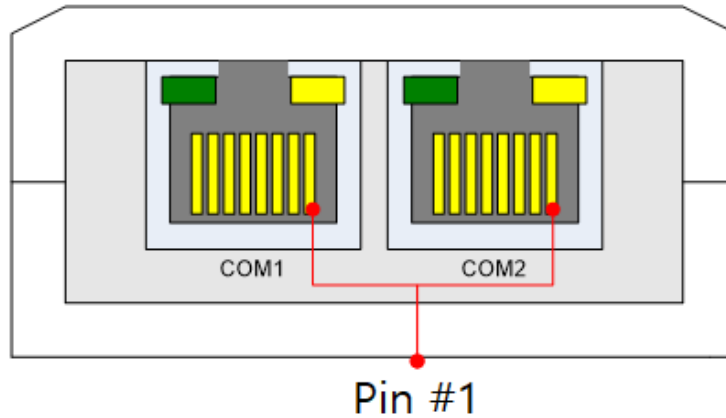

Figure 2-1 serial ports (RJ45)

- RS-232

Number	Name	Description	Level	I/O	Wiring
1	RTS	Request To Send	RS232	Out	Optional
2	DTR	Data Terminal Ready	RS232	Out	Optional
3	TXD	Transmit Data	RS232	Out	Required
4	GND	Ground	Ground	-	Required
5	GND	Ground	Ground	-	Required
6	RXD	Receive Data	RS232	In	Required
7	DSR	Data Set Ready	RS232	In	Optional
8	CTS	Clear To Send	RS232	In	Optional

Table 2-2 RS-232

- LEDs of Serial Port

Condition	Color	Operation
TCP disconnected	Green	OFF
	Yellow	
TCP connected	Green	As same as CTS (on: CTS active) Blinks if CSE-H20 gets data from the serial port.
	Yellow	As same as RTS (on: RTS active) Blinks if CSE-H20 sends data to the serial port.
UDP Mode	Green	As same as CTS (on: CTS active) Blinks if CSE-H20 gets data from the serial port.
	Yellow	As same as RTS (on: RTS active) Blinks if CSE-H20 sends data to the serial port.

Table 2-3 LEDs of serial port

- Data bits, Parity and Stop bit

Item	Configurable Value
Data bit	8, 7, 6, 5
Parity	None, Even, Odd, Mark, Space
Stop bit	1, 1.5, 2

Table 2-4 data bits, parity and stop bit

- Flow Control

CSE-H20 supports RTS/CTS Hardware Flow Control.

- Telnet COM Port Control Option (RFC2217)

CSE-H20 has Telnet COM Port Control Option function that is specified by RFC2217. If the Telnet COM Port Control Option is enabled, CSE-H20 sends the CTS, DSR control signal to the communication counterpart, and CSE-H20 sets its serial port items (RTS, DTR, Baud rate, data bits, parity, stop bit) after getting information from the communication counterpart.

- Disable TCP Transmission Delay

If you use this option, CSE-H20 sends the data from the serial port to Ethernet as quickly as possible.

- TX Delay

CSE-H20 has a function that delays its serial data for the user's slow device. User can set the interval between byte and byte which are outputting from CSE-H20's serial ports. Its unit is byte.

- TCP Server / Client mode

This mode is available on TCP client mode only. In this mode, you don't need to change the mode for switching active or passive TCP connection. Note that the [Event Byte] option should be set to 1 or larger value.

2.2.2 Ethernet Interface

Network part of CSE-H20 is configured with Ethernet. So, what you have to do is only to connect UTP cable. The Ethernet part detects 10Mbit or 100Mbit Ethernet automatically, to connect the corresponding cable. It also provides auto MDI/MDIX function to detect 1:1 cable or cross-over cable automatically.

Each piece of Ethernet equipment has unique hardware addresses, and CSE-H20 also has factory-set hardware address (which is called MAC address).

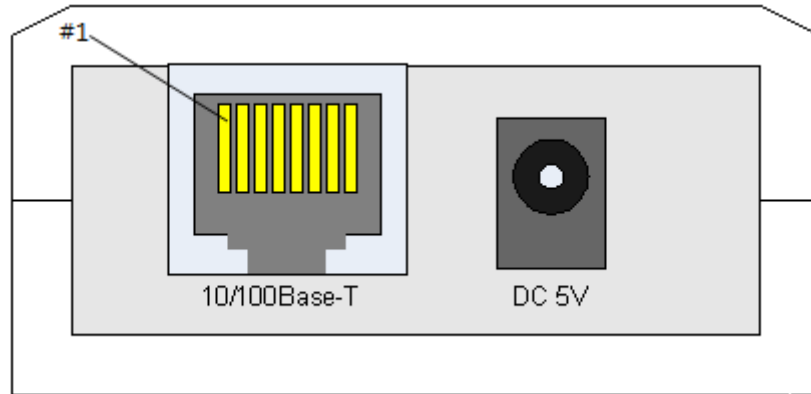

Figure 2-2 Ethernet interface

2.2.3 Power

DC 5V is used for CSE-H20 and the specification is below:

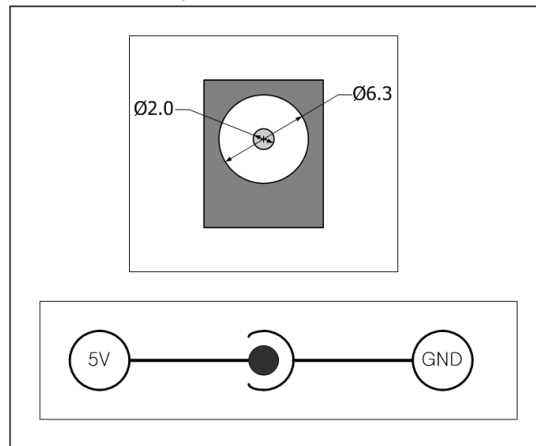

Figure 2-3 power

2.2.4 System LEDs

CSE-H20 has 5 system LEDs.

- System LEDs

Mode	Name	Color	LED Status	Description
Common	PWR	Red	ON	Power is supplied.
	LINK	Green	ON	Connected to 100M Ethernet.
		Red	ON	Connected to 10M Ethernet.
	RXD	Yellow	Blinking	There are data on the LAN
	TXD	Green	Blinking	Packets are being transmitted to Ethernet
Normal mode	STS	Yellow	Blinks in every second	IP is allocated but TCP connection is not established.
			Blinks 4 Times/sec	Dynamic IP is not allocated.
ISP mode	STS	Yellow	OFF	CSE-H20 is in the ISP mode
Serial Configuration mode	RXD/ TXD/ STS	-	Blink 2 Times/sec at one time	CSE-H20 is in the Serial Configuration mode

Figure 2-4 system LEDs

2.2.5 ISP Switch

There is an ISP switch on the side. If this switch is push 20ms~1s, it operates as Serial Configuration Mode. If this switch is push over 1 second, CSE-H20 operates as ISP mode. User can do firmware download to the CSE-H20 in the ISP mode. Please refer to 4.2 for more information on firmware download.

3 Installation and Test Run

3.1 Installation Method

You can install CSE-H20 in the following steps.

Title	Item	Sub-item
1. Checking the communication environment	Check items	IP address environment
		Serial port settings
		Application program to be used
2. Connecting to the network	Check method	Check if LINK LED is ON.
3. Configuring the environmental variables	Configuration method	Set by ezManager, a utility program for configuration through the network.
		Set by AT commands in ATC mode
	Configuration items	IP address related items
		Serial port related items
		Communication mode (depending on application program)
4. Application to the field		

Figure 3-1 installation method

3.1.1 Checking the Communication Environment

Before installing CSE-H20, check the network environment where CSE-H20 is to be installed, including the followings matters:

- IP address environment (local IP, subnet mask, gateway, DHCP/PPPoE etc.)
- Serial port type of the equipment to which CSE-H20 is going to be connected (RS232)
- Serial port items of the equipment to which CSE-H20 is going to be connected (baud rate, data bit, parity, stop bit, flow control)
- Application program protocol to be used (TCP/UDP, server/client, etc.)
- Security function (SSL, SSH, etc.)

3.1.2 Connecting to the Network

Connect power to CSE-H20, and connect CSE-H20 either directly to the Ethernet port of the PC where test is to be performed or to the network (hub) to which the PC is connected.

3.1.3 Configuring the Environmental Variables

When network connection is completed, configure the environmental variables such as IP address related items, serial port related items, and communication mode related items through the LAN using "ezManager" the environmental variable configuration program.

3.2 Test Run

You can perform test run according to the following orders. The test run described here is based on the assumption that the IP address of the PC is set to 10.1.0.2

3.2.1 Changing PC IP Address

You can change the IP address of your PC as follows:

IP Address	10.1.0.2
Subnet Mask	255.0.0.0
Gateway IP Address	-

Figure 3-2 changing PC IP address

3.2.2 Installing CSE-H20

Connect the supplied RS232 cable (RJ45-DB9F-1M) between your PC and CSE-H20, the LAN cable to the hub to which the PC is connected or directly to the PC, and the supplied CSE-H20 power adapter to CSE-H20 for power supply. If the LAN cable has been correctly connected when power is supplied, LINK LED turns on.

3.2.3 Configuring CSE-H20

Configure CSE-H20 setting using ezManager, the ezTCP configuration program, as follows.

Run ezManager, and click [Search All] button in the ezManager window. And, ezManager program will search all CSE-H20s on the local network.

When ezTCP is searched, MAC address of the ezTCP is displayed on the [Search Result] window (The MAC address is indicated at the bottom of the product case).

Select the corresponding MAC address, and set the variables considering your network environment.

When no ezTCP is found, check the Windows firewall. If you press [Windows Firewall] button in the ezManager, you can see the Windows Firewall menu directly.

For simple test, we recommend that the variables keep default values as shown in the below table.

Parameter		Value
Network	Local IP Address	10.1.0.1
	Subnet Mask	255.0.0.0
Option	Telnet	Enabled
	IP Address Search	Enabled
Serial Port (COM1/2)	Serial Type	RS232
	Baud Rate	19200bps
	Parity	NONE
	Data Bits	8
	Stop Bit	1
	Flow	NONE
	Communication Mode	T2S – TCP Server
	Local Port	1470/1471

Figure 3-3 configuring CSE-H20

3.2.4 Communication Test

Power the CSE-H20 off and on, then it tries to connect to the LAN.

- A program for testing starts if you press the [Simple Test] button of the ezManager.

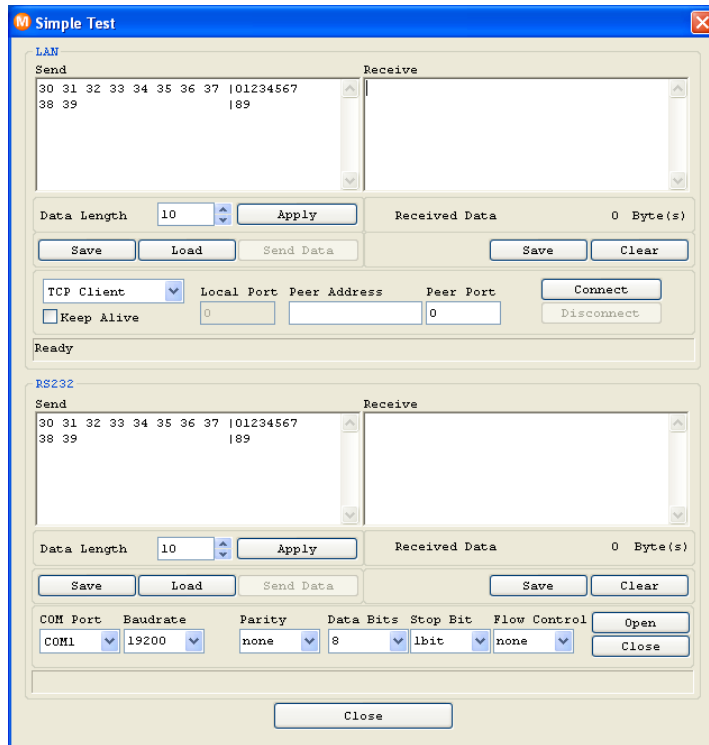

Figure 3-4 communication test 1

- Press the [Connect] button after inputting 10.1.0.1 and 1470 in the IP and Port. If the TCP connection is established there will be "Connected [10.1.0.1 : 1470]. And the STS indicator will be on.

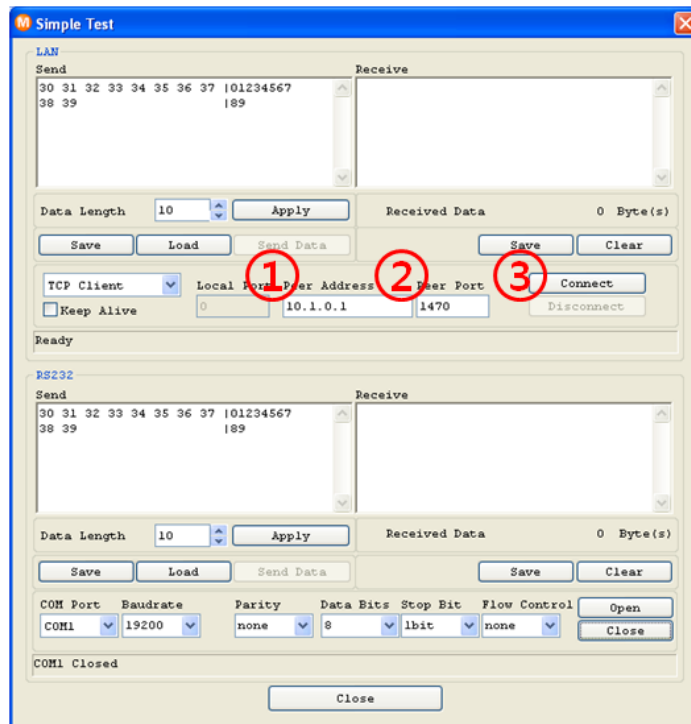

Figure 3-5 communication test 2

- Press the [Open] button after selecting serial port that is connected to the CSE-H20. If the serial port is open, the "COM1 the COM port has opened" message will be shown.

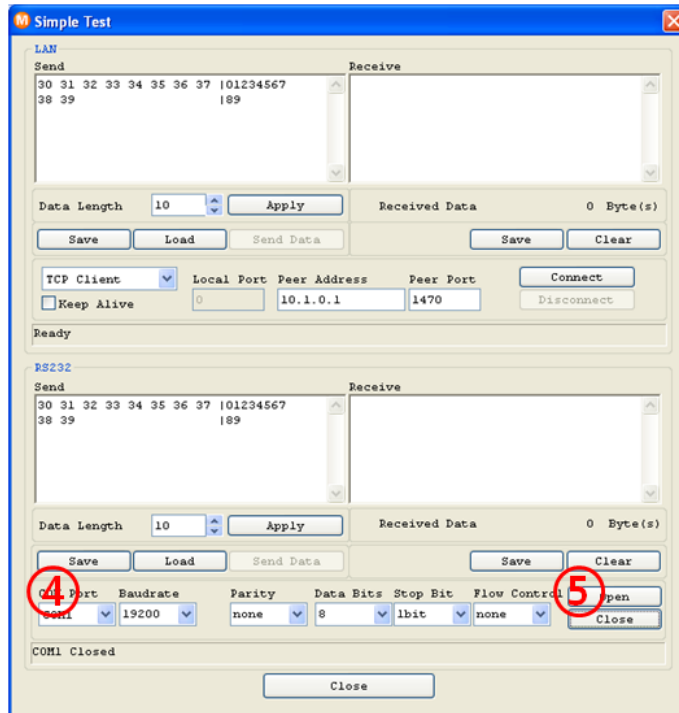

Figure 3-6 communication test 3

- If you press the [Send Data] button on the LAN part (Top), the data shown in the [Send] box will be transmitted to the [Receive] box on the RS232 part (Bottom).

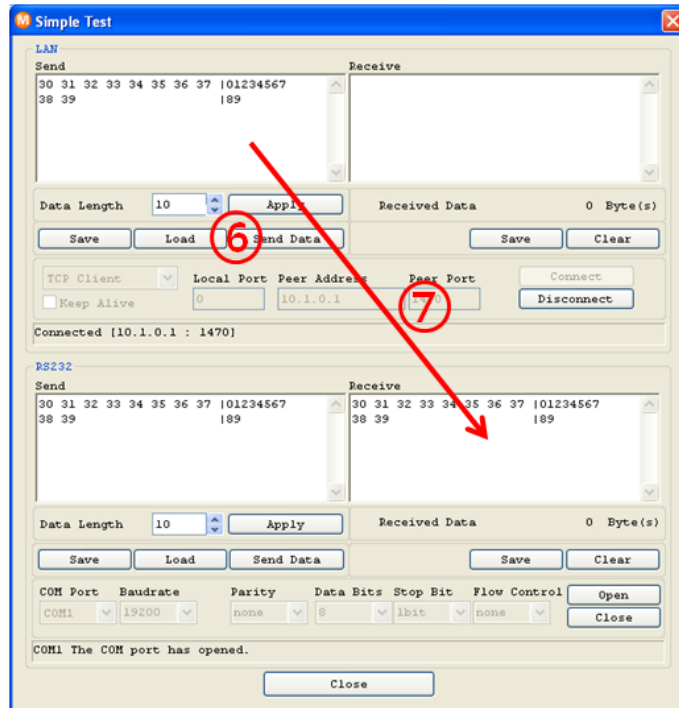

Figure 3-7 communication test 4

- If you press the [Send Data] button on the RS232 part (Bottom), the data shown in the [Send] box will be transmitted to the [Receive] box on the LAN part.

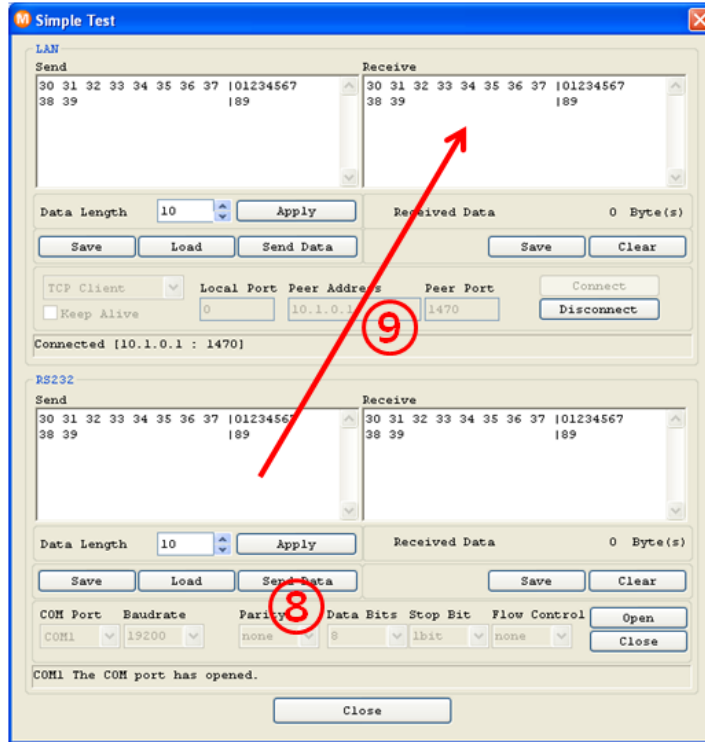

Figure 3-8 communication test 5

- If the transmitting and receiving data are same, the communication test is successful.

4 Configuring IP Address Variables

4.1 IP Address and Environmental Variables

For TCP/IP communication, you must set IP address related items. In addition, you have to set serial port related items (serial port type, communication speed, data bit length, parity bit, flow control and etc.) to CSE-H20.

You can set the IP address and the serial port related items by using ezManager, the supplied configuration utility which allows you to configure your CSE-H20 over the network, or by using AT commands in ATC mode.

4.2 Configuring with ezManager

4.2.1 ezManager

The basic environmental variables (IP address related items, serial port items, and etc.) can be set by ezManager which is an integrated management tool for Windows.

ezManager runs on Microsoft Windows and may not work on some older operating systems. Following is the screen shot of ezManager which is just launched.

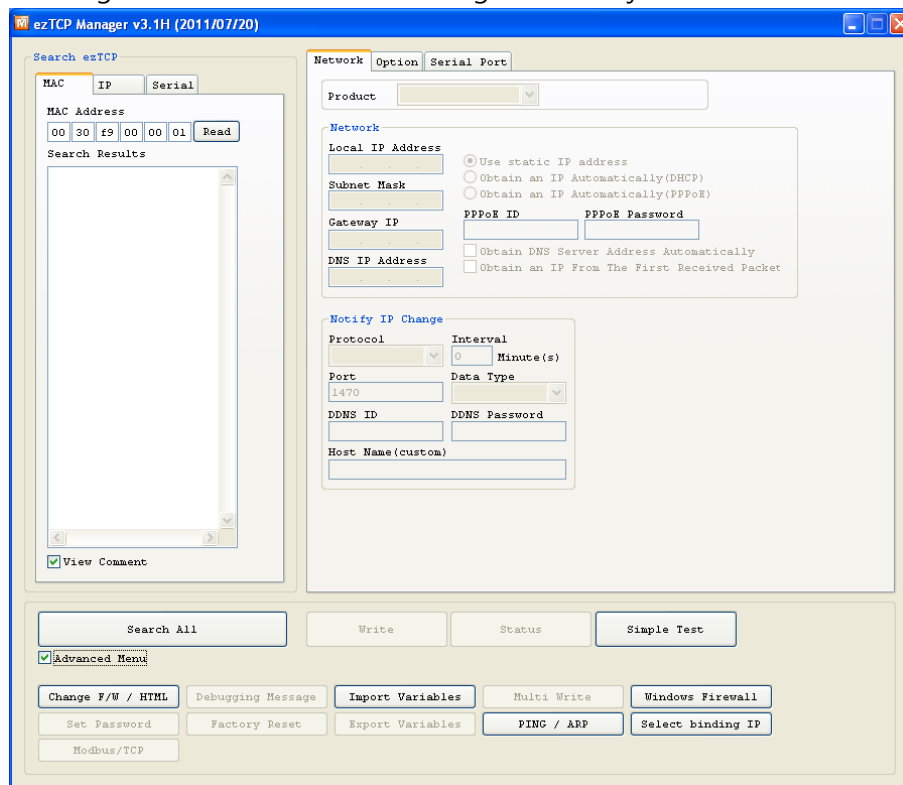

Figure 4-1 ezManager

- ezManager communicates UDP broadcast and its UDP ports are 50005 and 50006. Port number 50005 is for setting and port number 50006 is for debugging. If you use any firewall function, the ports have to be opened.

4.2.2 Buttons of ezManager

Button	Description
Read	Read the values configured through MAC or IP address.
Write	Store the changed values of parameters
Set Password	Set or remove the password by this button.
Status	Check the status of ezTCP in real time.
Factory Reset	Initialize all the values as a default.
Debugging Message	Make the ezTCP broadcast debugging messages.
Change F/W / HTML	Change the firmware or HTML files with this button.
Export Variables	Store a set of values as a file.
Import Variables	Load values from a file made from [Export Variables]
Multi Write	Configure a set of values to one or more ezTCP
PING/ARP	Test the PING reply and manage the ARP table.
Simple Test	Run the test program interfaced with Network and RS232 port.
Windows Firewall	Run the windows firewall set window.
Exit	Exit ezManager

Figure 4-2 buttons of ezManager

4.2.3 Parameters of ezManager

Tap	Section	Parameters
Network	Network	Local IP Address, Subnet Mask, Gateway IP, DNS IP Address
	Notify IP Change	Protocol, Interval, Port, Data Type, DDNS ID, DDNS Password, Host Name(dyndns/custom)
	Option	Obtain an IP From The First Received Packet, Obtain an IP Automatically (DHCP), Obtain an IP Automatically (PPPoE), PPPoE ID, PPPoE Password, Obtain DNS Server Address Automatically
Option	Option	Telnet, IP Address Search, Send MAC Address, Debugging Message, SSL, SSH, Multiple Connection
	ezTCP Firewall	Allowed MAC Address, Allowed IP Range, IP Address, Network Mask, Apply To ezManager
Serial Port	Serial Port	Serial Type, TTL, Baud Rate, Parity, Data Bits, Stop Bit, Flow Control, DTR/DSR, TX Interval

	TCP/IP	Communication Mode, Peer Address, Peer Port, Local Port, Event Byte, Timeout, Data Frame
--	--------	--

Figure 4-3 parameters of ezManager

4.2.4 Matters to be attended to

ezManager can be used when you want to change your device's environment variables. In case of CSE-H20, two interfaces are supported and those are Ethernet and RS232 port.

- Using Ethernet Port

For use ezManager through Ethernet, CSE-H20 should be connected with PC on networks. If they are located at the same network, [Search All], on the [MAC] tap, could be used with MAC address. If they are connected on Internet, [Read], on the [IP] tap, could be used.

- Using RS232 Port

For use ezManager through RS232, not only the CSE-H20 should be connected to PC with RS232 cross cable but also has to be operated as serial configuration mode.

4.3 AT command

In ATC mode, the user can set environment variables through the serial port using AT command.

☞ ***For more information, See "6.3 ATC Mode".***

4.4 Notify IP Change

In internet environment, most host get IP addresses dynamically. In this case, it is very hard to communicate to the host because the IP address is changed dynamically. The IP Change Trap service solves this problem. There are 3 types- DDNS, TCP and UDP- for this service.

4.4.1 DDNS (Dynamic Domain Name System)

If the CSE-H20 obtains its IP address, it notices to the service provider. Then the service provider serves DNS service. So, even though user doesn't know the CSE-H20's IP address, user can connect to the CSE-H20 by the host name (after DNS looking up.) The DDNS service provider that the CSE-H20 supports is only DynDNS (<https://dyn.com/dns/>) currently.

☞ ***All about service usage of an account could be changed according to the policy of DynDNS.***

4.4.2 TCP/UDP

In addition, CSE-H20 can transmit some information to user's TCP/UDP servers each period which is set. This information is IP address, MAC address, product ID, firmware version, and comment. The data can be sent as either ASCII or Hexadecimal type.

☞ ***For more details about the Notify IP Change, please refer to the "Change Notification of IP Address" document on our web site.***

☞ ***For more details about the ezManager, please refer to the "manual of ezManager" document on our web site.***

5 Operation Mode

5.1 Operation Mode Overview

5.1.1 Overview

CSE-H20 can operate in one of three modes (normal, serial configuration, and ISP modes). Normal mode is ordinary data communication mode; and serial configuration mode is a configuration mode through the serial port; and ISP mode is used to download CSE-H20 firmware through the Ethernet port.

5.2 How to Initiate Each Operation Mode

5.2.1 How to Initiate the Normal Mode

Normal mode is a mode in which CSE-H20 performs its original functions.

 **For more information, see "6. Normal Communication Mode."**

5.2.2 How to Initiate the Serial Configuration Mode

Pressing the ISP button for the time between 20ms and 1000ms (1sec), CSE-H20 works in the serial configuration mode.

5.2.3 How to Initiate the ISP Mode

If user press the ISP button hen CSE-H20 boots up or user press the button over 1 second in the normal mode, it operates as ISP mode that is firmware download mode.

5.2.4 Comparison of Operation Modes

The following table is the comparison of the above described operation modes.

Mode	How to Initiate	Description	Serial Port Communication Speed
Normal	ISP- pin open Or Pull-up	Normal data communication mode T2S, ATC, COD, U2S	User setting
Serial Configuration	Pressing the ISP button for 20ms ~ 1000ms	Configuring the environmental variables through the serial port.(COM1)	115200bps,N,8,1 Using the COM1 port
ISP	Pressing the ISP button when it boots up or pressing over 1 second.	Download firmware through the Ethernet port Disabled all security functions	115200bps,N,8,1 Using the COM1 port

Table 5-1 comparison of operation modes

5.3 Normal Communication Mode

Normal communication mode is suitable for the purpose of using CSE-H20.

Normal communication mode can be classified into four modes – T2S, ATC, COD, and U2S – each of which is described in the following table.

Communication Mode	Protocol	Connection	Need for User Equipment Software Modification	Configuration of Environmental Variables through Serial Port	Topology
T2S	TCP	Passive Connection	Not needed	Impossible	1:1
ATC	TCP	Active/Passive Connection	Needed	Possible	1:1
COD	TCP	Active Connection	Not needed	Impossible	1:1
U2S	UDP	No Connection	Not needed	Impossible	N:M

Table 5-2 normal communication mode

TCP protocol requires connection process. The connection is always established as 1:1 connection. At this time, the host waiting for connection (passive connection) is called a server and the one attempting to connect (active connection) is called a client.

On the other hand, UDP communicates by block unit without connection process. As UDP does not require connection, numbers of hosts can communicate at the same time.

5.4 Serial Configuration Mode

This mode is for configuration under condition which the network is unavailable. When entering this mode, parameters of CSE-H20 can be set by its COM1 port. [Serial] tap on the ezManager let users do this.

5.5 ISP Mode

5.5.1 Upgrading Firmware

In ISP mode, you can download a firmware (CSE-H20 operation software) provided by our company. There is another thing in this mode. If you forget your password set before, you can reset it by entering this mode. In ISP mode, all the security options including ezTCP firewall are removal.

The following is the firmware downloading procedure.

- Supply power with pressing ISP button or push the button over 1 second, then CSE-H20 operates in the ISP mode.
- Run hotflash that is supplied by us and input IP address of CSE-H20 and select the firmware with the [FILE] menu. Then, send it with [SEND] button. (Uncheck the [Verify firmware version] option.)

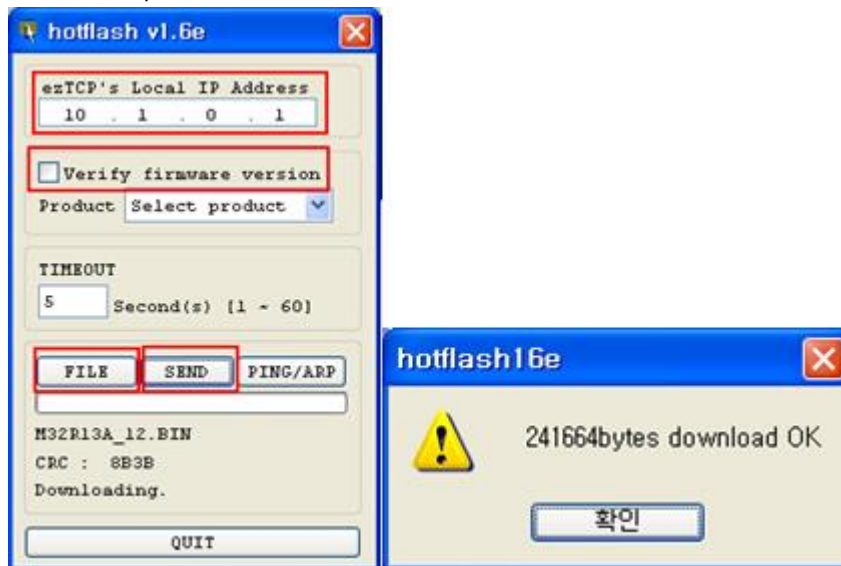

Figure 5-1 upgrading Firmware

- When the downloading is completed, CSE-H20 automatically reboots and enters normal mode.
- ☞ ***Firmware download can be implemented with ezManager whose version is 3.0A or subsequent version.***

6 Normal Communication Mode

6.1 T2S – TCP Server

In T2S mode, the CSE-H20 functions as a server.

When a host connects to predefined local port, the CSE-H20 accepts a TCP connection. When the ezTCP accepts TCP connection, then the TCP connection is established. After connection is established, TCP/IP processing is performed on the data coming to the serial port, which is then transmitted to the remote host. And the TCP/IP data coming from the remote host is TCP/IP-processed and transmitted to the serial port to establish data communication.

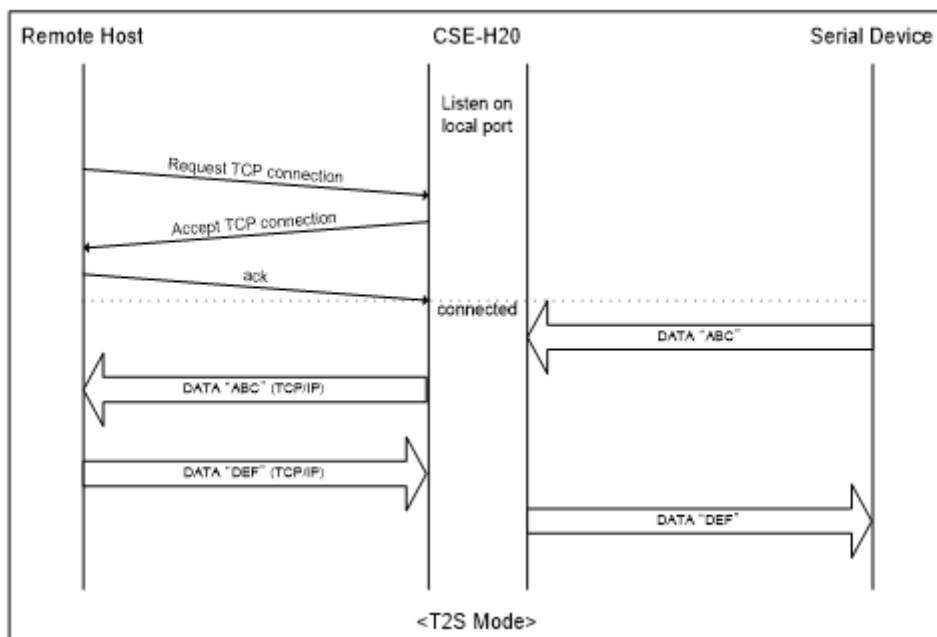

Figure 6-1 T2S - TCP server

6.1.1 TCP Connection

If a host connects to the pre-defined [Local Port] of CSE-H20, the host can communicate bi-directionally.

6.1.2 Serial Data before the TCP Connection

The received serial data before the TCP connection is established will be handled based on the [Event Byte] settings. If the [Event Byte] is 0, the data that comes to serial port of CSE-H20 will not be recognized. If it is not 0, the serial data before TCP connection will be temporarily saved to be sent to the host after the connection.

6.1.3 Data Transmission

When the TCP connection is established, the data communication in between the host and the serial device will be established. Then, CSE-H20 will send data according to the [Data Frame]. In other words, when the data comes through CSE-H20's serial port, it will be temporarily saved in the buffer. Then, when there is no incoming data during the designated [Data Frame], CSE-H20 will send the saved data. If the [Data Frame] is 0, CSE-H20 will send serial port's data immediately. The unit used for the [Data Frame] is 10m seconds, so CSE-H20 rounds down rest of the values.

6.1.4 Disconnection

When the connected host terminates the connection, or there is no data communication during the designated [Timeout], the TCP connection will be automatically terminated. The unit used for [Timeout] is 1 second.

6.2 COD – TCP Client

In COD mode, the ezTCP functions as a client.

When data of the pre-specified size [Event Byte] comes to the serial port, the ezTCP attempts a TCP connection to the TCP port [Peer Port] of the preset host IP [Peer IP Address]. If the remote host accepts the TCP connection, TCP connection will be established. Data coming to the serial port after connection establishment is TCP/IP-processed and transmitted to the remote host. And, data coming from the remote host is TCP/IP-processed and transmitted to the serial port for data communication.

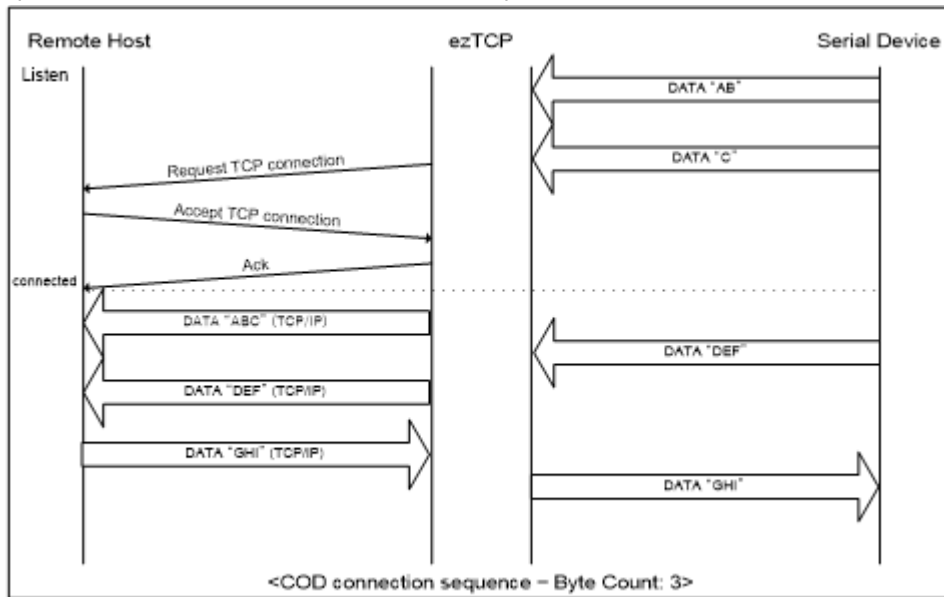

Figure 6-2 COD - TCP client

6.2.1 Serial Data before the TCP Connection

Data before TCP connection will be handled based on the [Event Byte] settings. If the [Event Byte] is 0, the data that comes to CSE-H20's serial port will not be recognized. If it is not 0, the serial data before TCP connection will be temporarily saved to be sent to the host after the connection.

6.2.2 Data Transmission

When the TCP connection is established, the data communication in between the host and the serial device will be established. Then, CSE-H20 will send data according to the [Data Frame]. In other words, when the data comes through CSE-H20's serial port, it will be temporarily saved in the buffer. Then, when there is no incoming data during the designated [Data Frame], CSE-H20 will send the saved data. If the [Data Frame] is 0, CSE-H20 will send serial port's data immediately. The unit used for the [Data Frame] is 10 milliseconds, so CSE-H20 rounds down rest of the values.

6.2.3 Disconnection

When the connected host terminates the connection, or there is no data communication during the designated [Timeout], the TCP connection will be automatically terminated. The unit used for [Timeout] is 1 second.

6.2.4 DNS

If users set the host name instead of the IP address on the [Peer Address] box, CSE-H20 query the IP address of the host to its Domain Name Server (DNS). The IP address of DNS can be configured on ezManager. If you set incorrect address on that box, the connection won't be established.

6.3 ATC – AT Command

AT command is a mode which users control CSE-H20 with AT command like controlling modem. In this mode, active and passive TCP connections are available. And users are allowed to configure some environmental parameters with extended commands.

6.3.1 Key parameters

The configuration should be implemented via the serial port of CSE-H20.

Table 6-1 some of extended commands for configuration

Commands	Description	Examples
+PLIP	Local IP Address	at+plip=10.1.0.1 <CR>
+PLP	Local Port	at+plp=1470 <CR>
+PRIP	Peer IP Address	at+prip=10.1.0.2 <CR>
+PRP	Peer Port	at+prp=1470 <CR>
+PDC	DHCP	at+pdc=1 (ON) <CR>
+PPE	PPPoE	at+ppe=1 (ON) <CR>
+PTO	Timeout	at+pto=10 <CR>
+PWP	Store setting	at+pwp <CR>

Table 6-1 key parameters

- Related items with IP Address and Local Port
Local port can be set as well as IP address related parameters like IP Address, Subnet Mask and Gateway IP Address.
- Peer Address / Peer Port
IP address and local port of a remote host are can be set.
- Type of assigning IP address: Manual, DHCP, PPPoE
Not only manual setting, also automatic assigning protocol (DHCP, PPPoE) are available.
- Others
Some of options including [Timeout] can be configured in this mode.

6.3.2 Examples

- TCP Server – setting parameters and passive connection

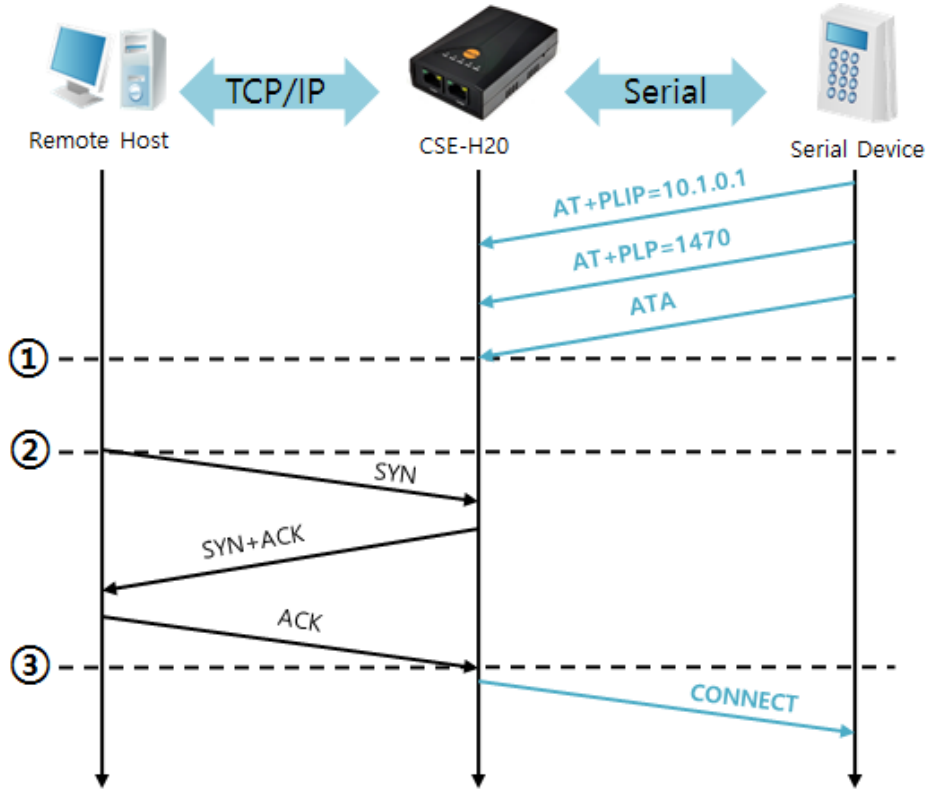

Figure 6-1 TCP passive connection

Points	States
~	Set parameters in the AT command mode
①	CSE-H20 listens TCP connection requests with the ATA command
~	CSE-H20 is listening TCP connection requests
②	A remote host has sent SYN segment to CSE-H20
~	Processes of TCP connection
③	TCP connection has been established
~	CSE-H20 sends "CONNECT" message to the serial port

Table 6-2 states of each point

☞ **Most of the response messages from the serial port of CSE-H20 are omitted on above figure.**

- TCP Client – setting parameters and active connection

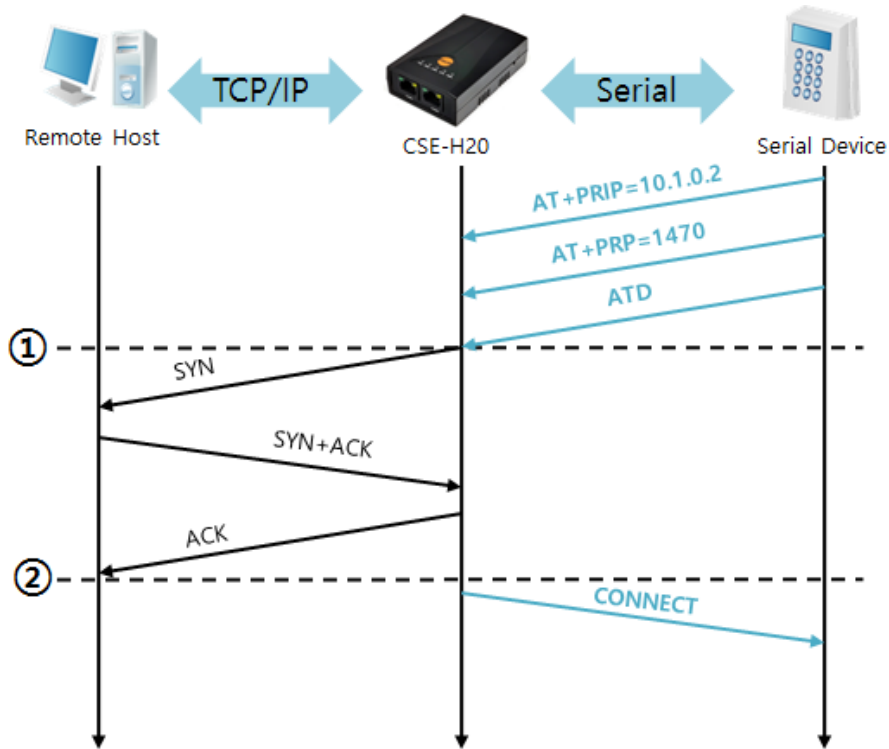

Figure 6-2 TCP Active connection

Points	States
~	Set parameters in the AT command mode
①	CSE-H20 sends a TCP connection request with the ATD command
~	Processes of TCP connection
②	TCP connection has been established
~	CSE-H20 sends "CONNECT" message to the serial port

Table 6-3 states of each point

- Termination of online status – entering the AT command mode

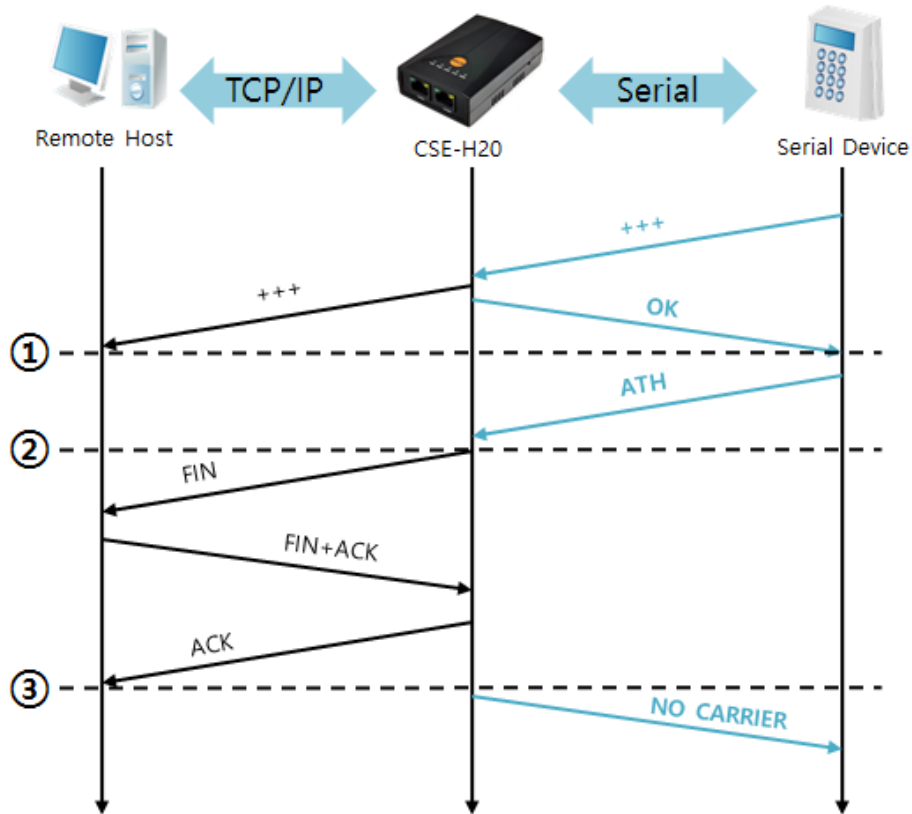

Figure 6-3 Termination of online status

Points	States
~	Keeps TCP connection
①	CSE-H20 enters the AT command mode with receiving "+++"
~	Keeps AC command mode
②	CSE-H20 terminates TCP connection with ATH command
~	Processes of TCP disconnection
③	TCP connection has been terminated
~	CSE-H20 sends "NO CARRIER" with disconnection

Table 6-4 states of each point

CSE-H20 changes the mode to AT command, when receiving "+++" and sending "OK" message. In this state, the communication with remote host is not possible because CSE-H20 processes only AT command. Whenever you want to go back to online state (TCP connection), use "ATO" command.

☞ ***For more information about AT command mode, please refer to the "ATC mode" on our web site.***

6.4 UDP

UDP has no processes of connection. In this mode, data is sent in block units. Therefore, data that comes through CSE-H20's serial port must be classified in block units to send it elsewhere.

6.4.1 Key parameters

- Block Size(Byte)

[Block Size(Byte)] means the size of a block in UDP mode. Its unit is byte. The size of bytes is come into the serial port, CSE-H20 sends them as one block to the network. The maximum value could be 1460 bytes.

- Data Frame

[Data Frame] means the time for gathering data to make one block. Its unit is 10ms. If there are no transmission during the time which is set to this value, CSE-H20 sends gathered data in the buffer as one block to the network.

☞ ***Please set this value to 11 or higher values for correct operation.***

☞ ***Once one of the parameters is sufficient, the block size is decided as the condition.***

- Dynamic update of Peer host

If users set the value of [Peer Address] and [Peer Port] to 0, [dynamic update of peer host] function is activated. By using this function, CSE-H20 can communicate to multiple hosts without additional setting.

☞ ***This function is available on 1.2H or subsequently released firmware version.***

6.4.2 Examples

- Block Size: 5 bytes / Data Frame: 1s (100 by 10ms)

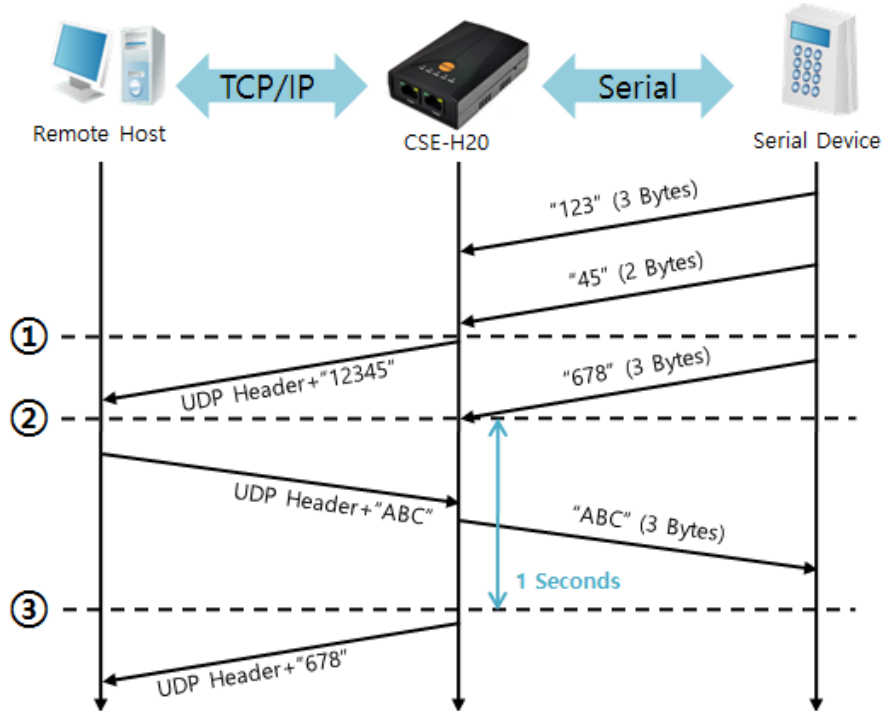

Figure 6-4 time chart for Block Size is 5 bytes and data frame is 1s

Points	States
~	CSE-H20 is receiving data from the serial port
①	CSE-H20 Sends 5 bytes as one block based on the [Block Size]
~	Serial device sends data "678" to the CSE-H20
②	Data "678" has arrived
~	CSE-H20 sends data from the remote host to the serial device
③	1 second has passed
~	CSE-H20 sends data "678" based on the [Data frame]

Table 6-5 states of each point

- Dynamic Update of Peer host

This is a function that CSE-H20 automatically sets its peer host with information of the last packet which is received from network. In the packet, the source address and port number is used.

Parameters	Values
Peer Address	0 (None)
Peer Port	0

Table 6-6 setting for [dynamic update of peer host] function

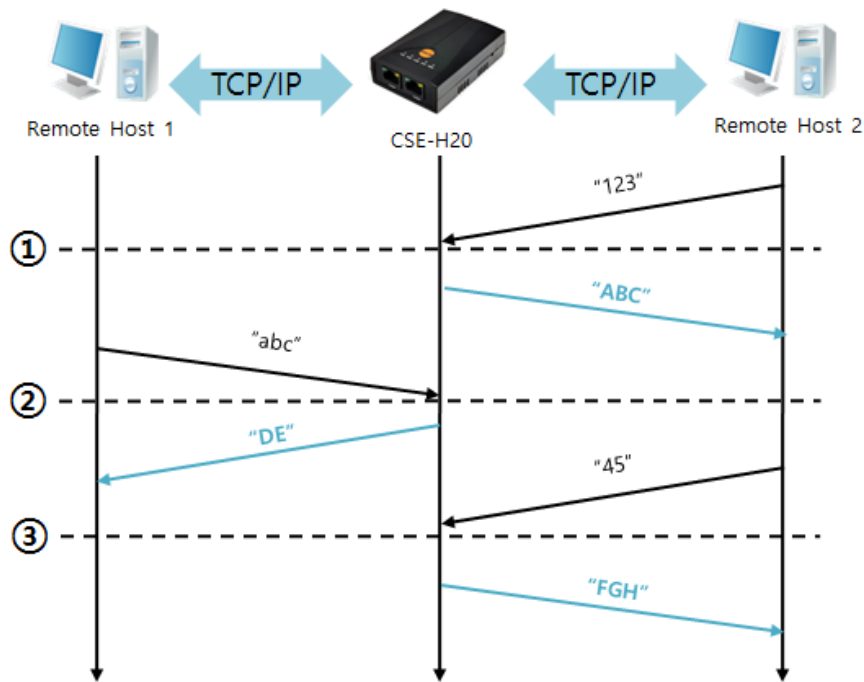

Figure 6-5 time chart for [dynamic update of peer host]

Points	States
~	Remote host 2 sends data to CSE-H20
①	CSE-H20 sets host 2 to peer host
~	Remote host 1 sends data to CSE-H20
②	CSE-H20 updates host 1 to peer host
~	Remote host 2 sends data again to CSE-H20
③	CSE-H20 updates host 2 to peer host
~	CSE-H20 can communicate with remote host 2

Table 6-7 states of each point

☞ **The data "ABC", "DE", "FGH" are from the serial port of CSE-H20 in the Fig 6-5.**

7 Security Protocols & Option

7.1 SSL

7.1.1 SSL (Secure Socket Layer)

SSL is cryptographic protocol that provides secure communication on the Internet. The SSL works over TCP.

7.1.2 How to set the SSL on CSE-H20

To works for SSL, you have to set the SSL-related parameters as the following steps.

- Set the [SSL] check box in the ezManager.

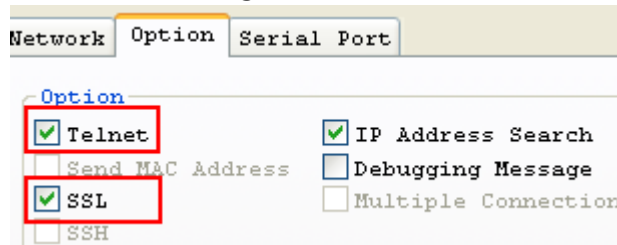

Figure 7-1 SSL 1

- Log in the CSE-H20 with telnet client.

☞ For telnet login, please refer to the section 8.1.1

- Generate an RSA key with a command. CSE-H20 supports 512, 768, and 1024 length keys.

Command Format: `rsa keygen [key length]`

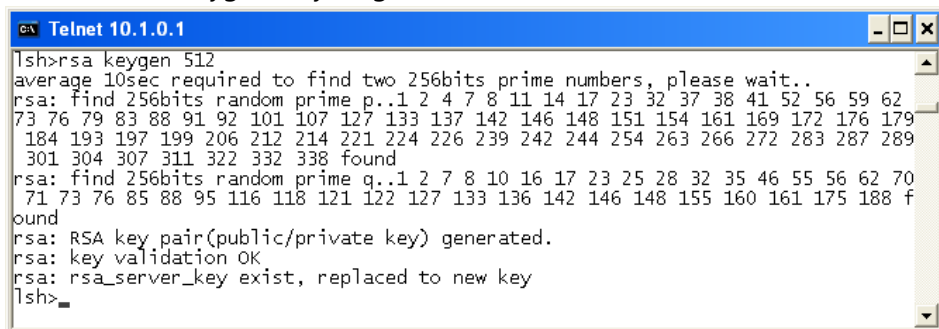
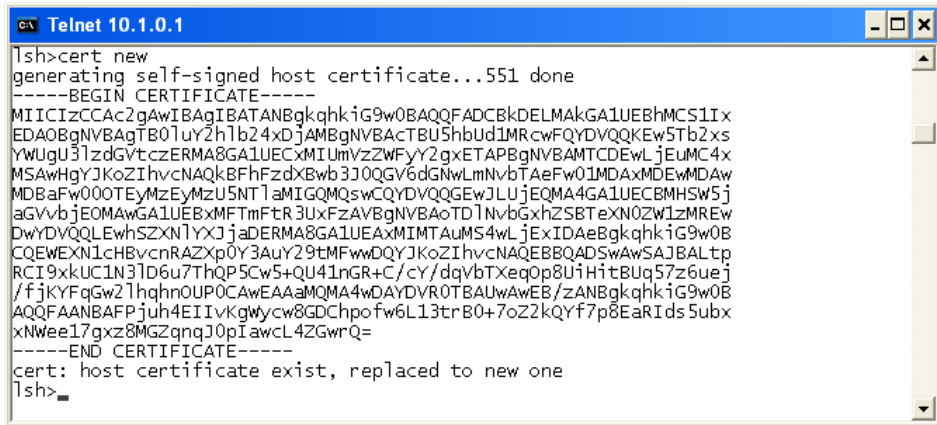

Figure 7-2 SSL 2

- Make a certificate with a 'cert new' command. The certificate is a self-signed.



```

C:\ Telnet 10.1.0.1
|sh>cert new
generating self-signed host certificate...551 done
-----BEGIN CERTIFICATE-----
MIICIZCCAc2gAwIBAgIBATANBgkqhkiG9w0BAQQFADCBkDELMAkGA1UEBhMCS1Ix
EDA0BgNVBAGTB01uy2h1b24xdjAMBgNVBAcTBUShbUd1MRcwFQYDVQKEw5Tb2xs
YWUgU3lzdGltczERMGA1UECXMlUmVzZWZyY2gxETAPBgNVBAMTCDEwLjEuMC4x
MSAwHgYJKoZIhvcNAQkBFhFzdXBwb3J0QG9v6dGNwLmNvbTAeFw01MDAxMDEwMDAw
MDBaFw000TEyMzU5NTlzMIGQMqswCQYDVQGEwJLUjEQA4GA1UECBMHSW5j
aG9vbnRlEOMAwGA1UEBxMFTmFtR3UxZmFzAVBgNVBAoTD1NvbG9hZSBTeXN0ZWlzMREw
DwYDVQQLEwhSZXNlYXJjaDERMA8GA1UEAxMIMTAuMS4wLjEwIDAeBgkqhkiG9w0B
CQEWEhN1cHBvcnRAZDp0Y3AuY29tMFwwDQYJKoZIhvcNAQEBBQADSwAwSAJBALtp
RCI9xkUC1N31D6u7ThQP5Cw5+QU41nGR+C/cY/dqVbTXeq0p8UiHitBUq57z6uej
/fjKYFqGw2lhqhnOUP0CAwEAAaMQMA4wDAYDVR0TBAAUwAwEB/zANBgkqhkiG9w0B
AQQFAANBAFPjuh4EIIvKgwycw8GDChpo6fw6L13trB0+7oZ2kQYf7p8EaRIidsSubx
xNWee17gxz8MGZgnqJ0pIawcL4ZGwrQ=
-----END CERTIFICATE-----
cert: host certificate exist, replaced to new one
|sh>

```

Figure 7-3 SSL 3

- Save the parameters for SSL with a 'ssl save aa55cc33' command.

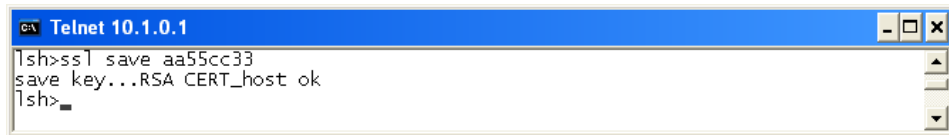

```

C:\ Telnet 10.1.0.1
|sh>ssl save aa55cc33
save key...RSA CERT_host ok
|sh>

```

Figure 7-4 SSL 4

7.1.3 Restriction

To use the SSL with CSE-H20, there is a restriction. You can use only one serial port (COM1) if you set the SSL function.

7.2 SSH

7.2.1 SSH (Secure Shell)

SSH is a network protocol that allows secure communications between two devices. You can use this function if your device is a serial port for console and you need secure communication.

7.2.2 How to set the SSH on CSE-H20

To works for SSL, you have to set the SSH-related parameters as the following steps.

- Set the [SSH] check box in the ezManager.

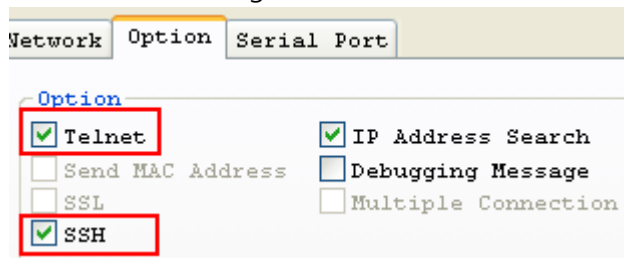

Figure 7-5 SSH 1

- Log in the CSE-H20 with telnet client.

☞ ***For telnet login, please refer to the section 8.1.1***

- Generate an RSA key with a command. CSE-H20 supports 512, 768, and 1024 length keys.

Command Format: `rsa keygen [key length]`

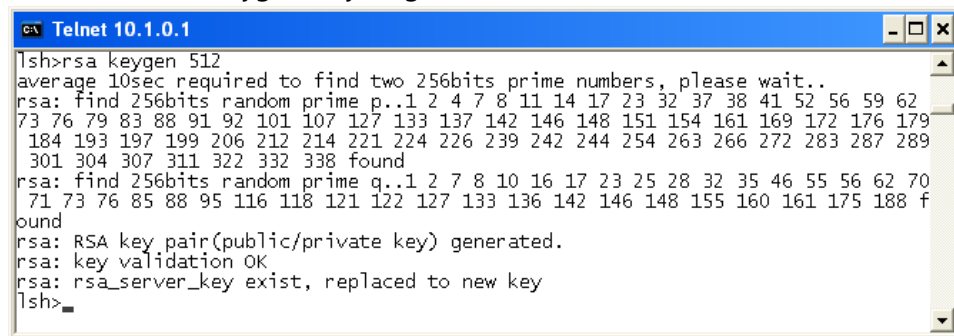
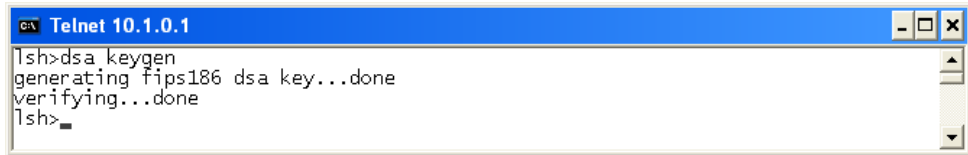

Figure 7-6 SSH 2

- Generate a DSA key with a 'dsa keygen'.



```
CA Telnet 10.1.0.1
lsh>dsa keygen
generating fips186 dsa key...done
verifying...done
lsh>
```

Figure 7-7 SSH 3

- Set a username and a password to log in with a 'ssh id' command for the SSH.

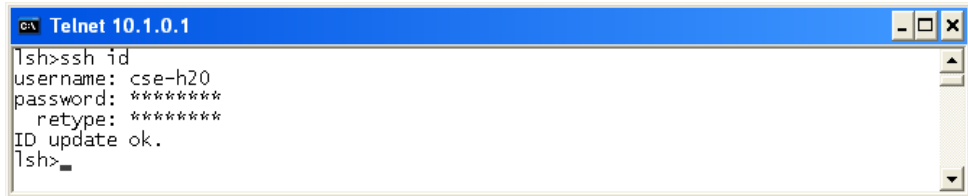

```
CA Telnet 10.1.0.1
lsh>ssh id
username: cse-h20
password: *****
retype: *****
ID update ok.
lsh>
```

Figure 7-8 SSH 4

- Save the parameters for SSH with a 'ssh save aa55cc33' command.

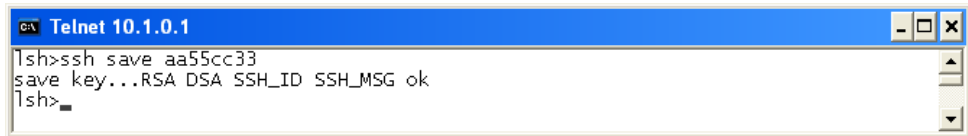

```
CA Telnet 10.1.0.1
lsh>ssh save aa55cc33
save key...RSA DSA SSH_ID SSH_MSG ok
lsh>
```

Figure 7-9 SSH 5

7.2.3 Restriction

To use the SSH function with CSE-H20, there is a restriction. You can use only T2S mode (TCP Server mode) if you set the SSH function

7.3 ezTCP Firewall

CSE-H20 has two connection limitation functions. Those can be set by the [Option] tab of the ezManager.

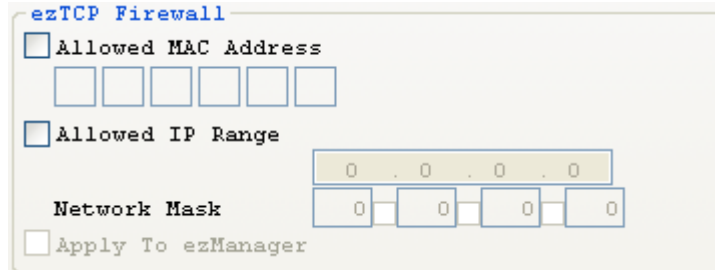

Figure 7-10 ezTCP Firewall

- Allowed MAC Address

If user sets the [Allowed MAC Address], the only specified host can be connected with the CSE-H20.

- Allowed IP Range

When the [Allowed IP] is set, the only hosts that are specified by [Allowed IP] and [Network Mask] can connect to the CSE-H20.

- examples

Allowed IP	Net Mask	Hosts who can connect to the CSE-H20
10.1.0.1	255.0.0.0	10.1.0.1 ~ 10.255.255.254
10.1.0.1	255.255.255.0	10.1.0.1 ~ 10.1.0.254
192.168.1.4	255.255.255.255	192.168.1.4

Table 7-1 examples

- Apply to ezManager

If this option is checked, hosts who are not specified above two restrictions can't search and configure CSE-H20 with ezManager. This is enabled when one of restrictions is set at least.

☞ ***All security functions are disabled in the ISP mode. Thus, users can access the CSE-H20 in the ISP mode even though user can't access the CSE-H20 in the normal mode because of the [ezTCP Firewall] function.***

8 Checking & Debugging

If user logs in the CSE-H20, user can monitor CSE-H20 status. And if user sets the debugging option, user can get debugging data with ezManager.

8.1 Telnet

8.1.1 Telnet Login

Once the [TELNET] option is activated, users can remotely log in to CSE-H20. If a password is set, users should input the password.

☞ ***Starting with firmware version 2.0A, you can login by entering "sollae" without setting a password.***

After then, messages from CSE-H20 appear like the below figure.

```
CSE-H20 Management Console v2.0A Sollae Systems
password: *****
lsh>
```

Figure 8-1 TELNET login

8.1.2 Commands

- Network Status

User can monitor network status of CSE-H20 with the "st net" command.

```
lsh>st net
proto name local address peer address sendq state
-----
TCP tty 10.1.0.1( 23) 10.6.0.50(49432) 140 ESTABLISHED
TCP com2 0.0.0.0( 1471) 0.0.0.0( 0) 0 LISTEN
TCP com1 0.0.0.0( 1470) 0.0.0.0( 0) 0 LISTEN
lsh>
```

Figure 8-2 network status

- Serial Ports' Status

User can monitor the statuses of two serial ports with the "st sio" command. The tx_count and the rx_count are the total data sizes to/from the serial ports.

```
lsh>st sio
port fmax rbmax rxbuf txbuf rx_count tx_count
-----
com1 0 0 0 0 0 0
com2 0 0 0 0 0 0
lsh>
```

Figure 8-3 serial ports' status

- Checking Uptime

With "st uptime" command, you can check the time of your device boots up.

```
lsh>st uptime
01:53:38.24 up 0 days
lsh>
```

Figure 8-4 checking uptime

- Serial Ports I/O data capture

This command is available on 1.2H or subsequently released firmware version. User can monitor the input / output data of CSE-H20's serial ports with the "sd" command. The way of using this command is like below.

```
"sd [SPACE] [# of Serial Port] [SPACE] [Interval]"
```

The value of [# of Serial Port] is that COM1 is "1" and COM2 is "2". [Interval] means duration of capturing and printing data on your screen and its unit is mile second (ms).

For example, if you want to capture the data in every second, the value of [Interval] should be 100.

```
lsh>sd 1 100
com1 dump start
com1 dump buffering time : 1000ms
lsh>tx1 => 30 31 32 33 34 35 36 37           | 01234567
tx1 => 30 31 32 33 34 35 36 37           | 01234567
```

Figure 8-5 serial port I/O data capture

If you set 0 to the [option2], the capturing I/O data will be stopped.

```
lsh>sd 1 0
com 1 dump stop
lsh>
```

Figure 8-6 stopping capturing data

- Termination of TCP connection

Using "sc" command, users can terminate established TCP connection. The way of using this command is like below.

```
"sc [SPACE] [Name of Serial Port] [SPACE] close"
```

```
lsh>sc com1 close
com1: closed
lsh>
```

Figure 8-7 termination of TCP connection

8.2 Status on ezManager

8.2.1 Status of the CSE-H20

If the [Status] button is pressed on ezManager, user can monitor the current status of the CSE-H20 with ezManager. If user sets [Refresh Every 1 second] option, the status data will be updated in every second.

8.2.2 Closing TCP connection by the ezManager

User can terminate a TCP connection with the status window of the ezManager. If user clicks the right button of each TCP connection message of the TCP/IP Connection, user can terminate the TCP connection.

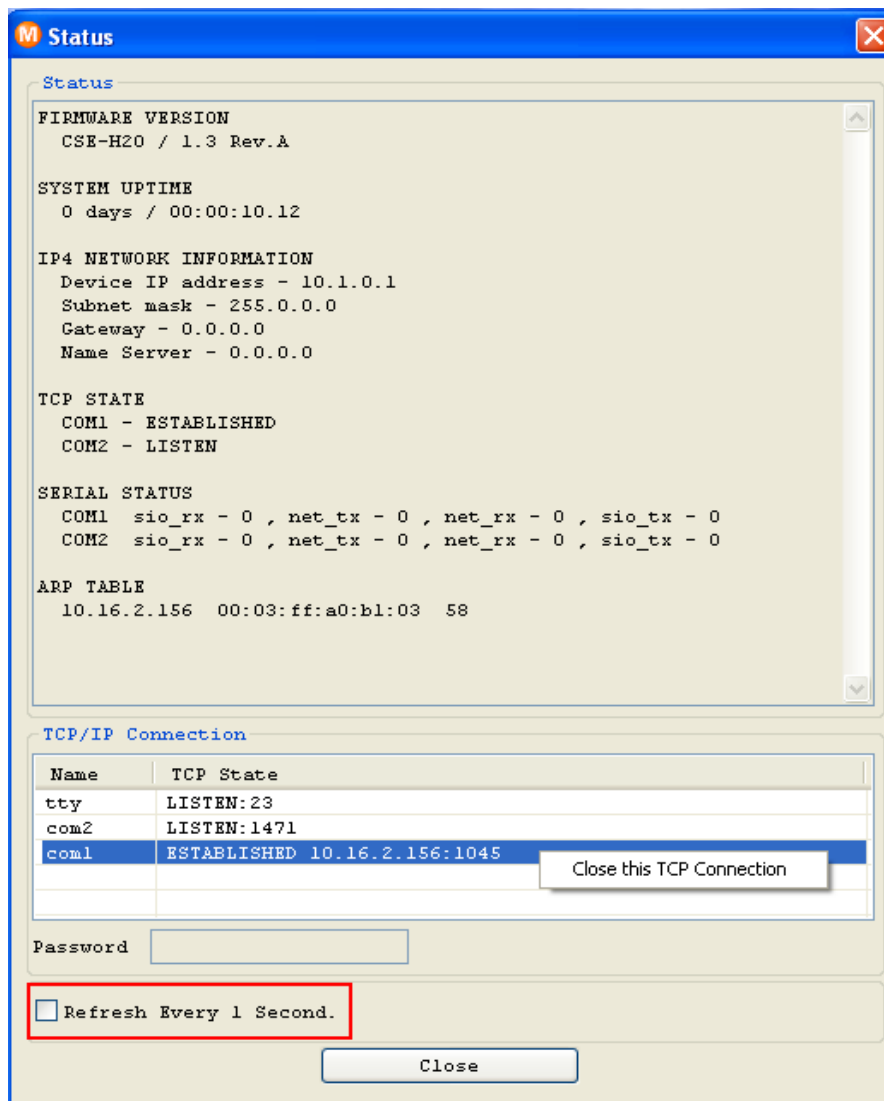

Figure 8-8 closing TCP connection by the ezManager

8.3 Remote Debugging

If the [Debugging Message] field in the [OPTION] tab of the ezManager, CSE-H20 transmits debugging messages with UDP port 50006. Then user can get the messages with new window if user presses [Debugging Message] button as followed:

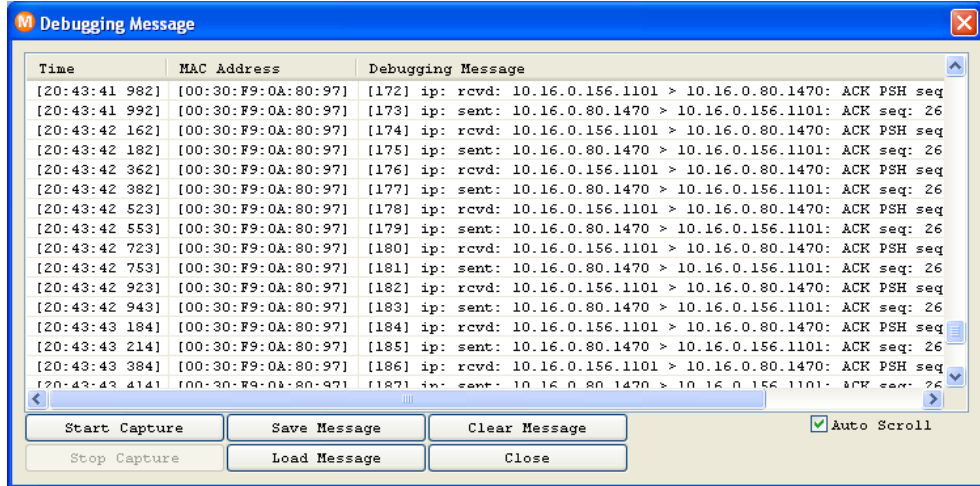

Figure 8-9 remote debugging

This function is very useful when there are any problems when users install the CSE-H20 in the user site.

8.4 Sending MAC Address

[Sending MAC Address] is a function that CSE-H20 sends its MAC address to the remote host right after the connection is established. By using this function, a server can identify multiple devices with the information.

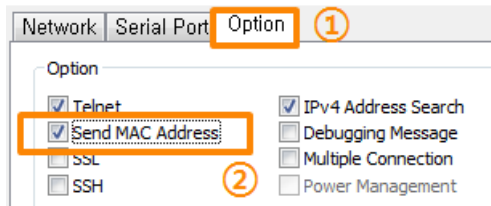

Figure 8-10 sending MAC address

- ① Move to the [Option] tab.
- ② Check the [Send MAC Address] option

This function is available on 1.3A or subsequently released firmware version.

9 Technical Support and Warranty

9.1 Technical Support

If you have any question regarding operation of the product, visit Customer Support FAQ corner and the message board on Sollae Systems' web site or send us an email at the following address:

- E-mail: support@eztcp.com
- Website Address for Customer Support: <https://www.eztcp.com/en/support/>

9.2 Warranty

9.2.1 Refund

Upon the customer's request to refund the product within two weeks after purchase, Sollae Systems will refund the product.

9.2.2 Free Repair Services

For product failures occurring within 2 years after purchase, Sollae Systems provides free repair services or exchange the product. However, if the product failure is due to user's fault, repair service fees will be charged or the product will be replaced at user's expense.

9.2.3 Charged Repair Services

For product failures occurring after the warranty period (2 years) or resulting from user's fault, repair service fees will be charged and the product will be replaced at user's expense.

10 Precaution and Exemption from Liability

10.1 Precaution

- Sollae Systems is not responsible for product failures occurring due to user's alteration of the product.
- Specifications of the product are subject to change without prior notice for performance improvement.
- Sollae Systems does not guarantee successful operation of the product if the product was used under conditions deviating from the product specifications.
- Reverse engineering of firmware and applications provided by Sollae Systems is prohibited.
- Use of firmware and applications provided by Sollae Systems for purposes other than those for which they were designed is prohibited.
- Do not use the product in an extremely cold or hot place or in a place where vibration is severe.
- Do not use the product in an environment in which humidity is high or a lot of oil exists.
- Do not use the product where there is caustic or combustible gas.
- Sollae Systems does not guarantee normal operation of the product under the conditions a lot of noise exists.
- Do not use the product for a purpose that requires exceptional quality and reliability relating to user's injuries or accidents – aerospace, aviation, health care, nuclear power, transportation, and safety purposes.
- Sollae Systems is not responsible for any accident or damage occurring while using the product.

10.2 Exemption from Liability

10.2.1 English version

In no event shall Sollae Systems Co., Ltd. And its distributors be liable for any damages whatsoever (including, without limitation, damages for loss of profit, operating cost for commercial interruption, loss of information, or any other financial loss) from the use or inability to use the CSE-H20 even if Sollae Systems Co., Ltd. Or its distributors have been informed of such damages.

The CSE-H20 is not designed and not authorized for use in military applications, in nuclear applications, in airport applications or for use in applications involving explosives, or in medical applications, or for use in security alarm, or for use in a fire alarm, or in applications involving elevators, or in embedded applications in vehicles such as but not limited to cars, planes, trucks, boats, aircraft, helicopters, etc..

In the same way, the CSE-H20 is not designed, or intended, or authorized to test, develop, or be built into applications where failure could create a dangerous situation that may result in financial losses, damage to property, personal injury, or the death of people or animals. If you use the CSE-H20 voluntarily or involuntarily for such unauthorized applications, you agree to subtract Sollae Systems Co., Ltd. And its distributors from all liability for any claim for compensation.

Sollae Systems Co., Ltd. And its distributors entire liability and your exclusive remedy shall be Sollae Systems Co., Ltd. And its distributors option for the return of the price paid for, or repair, or replacement of the CSE-H20.

Sollae Systems Co., Ltd. And its distributors disclaim all other warranties, either expressed or implied, including, but not limited to, the implied warranties of merchantability and fitness for a particular purpose, with respect to the CSE-H20 including accompanying written material, hardware and firmware.

10.2.2 French version

- Documentation

La documentation du boîtier CSE-H20 est conçue avec la plus grande attention. Tous les efforts ont été mis en œuvre pour éviter les anomalies. Toutefois, nous ne pouvons garantir que cette documentation soit à 100% exempt de toute erreur. Les informations présentes dans cette documentation sont données à titre indicatif. Les caractéristiques techniques peuvent changer à tout moment sans aucun préavis dans le but d'améliorer la qualité et les possibilités des produits.



- Copyright et appellations commerciales

Toutes les marques, les procédés, les références et les appellations commerciales des produits cités dans la documentation appartiennent à leur propriétaire et Fabricant respectif.

- Conditions d'utilisations et limite de responsabilité

En aucun cas Sollae Systems Co., Ltd. ou un de ses distributeurs ne pourra être tenu responsable de dommages quels qu'ils soient (intégrant, mais sans limitation, les dommages pour perte de bénéfice commercial, interruption d'exploitation commerciale, perte d'informations et de données à caractère commercial ou de toute autre perte financière) provenant de l'utilisation ou de l'incapacité à pouvoir utiliser le boîtier CSE-H20, même si Sollae Systems Co., Ltd. ou un de ses distributeurs a été informé de la possibilité de tels dommages.

Le boîtier CSE-H20 est exclusivement prévu pour un usage en intérieur, dans un environnement sec, tempéré (+10 °C à +40°C) et non poussiéreux. Le boîtier CSE-H20 n'est pas prévu, ni autorisé pour être utilisé en extérieur, ni de façon embarquée dans des engins mobiles de quelque nature que ce soit (voiture, camion, train, avion, etc...), ni en milieu explosif, ni dans des enceintes nucléaires, ni dans des ascenseurs, ni dans des aéroports, ni dans des enceintes hospitaliers, ni pour des applications à caractère médical, ni dans des dispositifs de détection et d'alerte anti-intrusion, ni dans des dispositifs de détection et d'alerte anti-incendie, ni dans des dispositifs d'alarme GTC, ni pour des applications militaires.

De même, le boîtier CSE-H20 n'est pas conçu, ni destiné, ni autorisé pour expérimenter, développer ou être intégré au sein d'applications dans lesquelles une défaillance de celui-ci pourrait créer une situation dangereuse pouvant entraîner des pertes financières, des dégâts matériel, des blessures corporelles ou la mort de personnes ou d'animaux. Si vous utilisez le boîtier CSE-H20 volontairement ou involontairement pour de telles applications non autorisées, vous vous engagez à soustraire Sollae Systems Co., Ltd. et ses distributeurs de toute responsabilité et de toute demande de dédommagement.

En cas de litige, l'entière responsabilité de Sollae Systems Co., Ltd. et de ses distributeurs vis-à-vis de votre recours durant la période de garantie se limitera exclusivement selon le choix de Sollae Systems Co., Ltd. et de ses distributeurs au remboursement de votre produit ou de sa réparation ou de son échange. Sollae Systems Co., Ltd. et ses distributeurs démentent toutes autres garanties, exprimées ou implicites.

Tous les boîtiers CSE-H20 sont testés avant expédition. Toute utilisation en dehors des spécifications et limites indiquées dans cette documentation ainsi que les court-circuit, les chocs, les utilisations non autorisées, pourront affecter la fiabilité, créer des dysfonctionnements et/ou la destruction du boîtier CSE-H20 sans que la responsabilité de Sollae Systems Co., Ltd. et de ses distributeurs ne puissent être mise en cause, ni que le boîtier CSE-H20 puisse être échangé au titre de la garantie.

- Rappel sur l'évacuation des équipements électroniques usagés

Le symbole de la poubelle barré présent sur le boîtier CSE-H20 indique que vous ne pouvez pas vous débarrasser de ce dernier de la même façon que vos déchets courants. Au contraire, vous êtes responsable de l'évacuation du boîtier CSE-H20 lorsqu'il arrive en fin de vie (ou qu'il est hors d'usage) et à cet effet, vous êtes tenu de le remettre à un point de collecte agréé pour le recyclage des équipements électriques et électroniques usagés. Le tri, l'évacuation et le recyclage séparés de vos équipements usagés permettent de préserver les ressources naturelles et de s'assurer que ces équipements sont recyclés dans le respect de la santé humaine et de l'environnement. Pour plus d'informations sur les lieux de collecte des équipements électroniques usagés, contacter votre mairie ou votre service local de traitement des déchets.

11 Revision History

Date	Version	Comment	Author
Jan.15.2007	0.5	Initial touch	
Feb.22.2007	1.0	Initial release	
Aug.31.2007	1.1	Add Serial Interface Add Telnet COM Port Control Option	
Sep.27.2007	1.2	Add DDNS(Dynamic DNS) function	
Dec.04.2008	1.3	Add SSL, SSH function Modify ISP- pin function Modify RTS/CTS Flow-control Modify Test Method Add AT+PNIP, AT+PRHN Add Connect with a host name in ATC Mode Add Close TCP function	
Jan.07.2009	1.4	Add security function in the ISP mode	
Mar.04.2009	1.5	Add description of serial I/O data capture by using telnet.(sd command) Add description of U2S echo Correct Some Expressions	
Mar.31.2009	1.6	Modify the table of 2.3.4. System LEDs Modify the table of 7.7.1 Modify 10.1 Technical Support Correct Some Expressions	
Apr.21.2009	1.7	Modify the table of 2.3.4. System LEDs	
Jul.13.2009	1.8	Add description of Send MAC Address function Add description of AT+PSE command Add description of changing local port in ATC mode Add description of Termination of TCP connection in 9.1.2 Update most of pictures including ezManager and Telnet Modify the 4.2 Configuration with ezManager Modify the description about F/W upgrade Modify the 4.6 Notify IP change Change the form of document Correct some expressions	
Aug.03.2011	1.9	○ Add description of serial options. (FIFO, Data	Amy KIM

		frame interval... etc) ○ Update a screenshot of ezManager.	
Jan.11.2012	2.0	○ Caution about service using of DynDNS has been added ○ Descriptions of FIFO function has been deleted.	Peter LEE
June.21.2012	2.1	○ Extend the warranty period to two years ○ Change description of network interface ○ Remove description about PPPoE and DHCP	Peter LEE
May.14.2013	2.2	○ Add related material ○ Add exemption from liability	Peter LEE
Jan.02.2014	2.3	○ Correct some errors and expressions ○ Modify the description about ATC mode ○ Modify the description about UDP	Peter LEE
Mar.22.2016	2.5	○ Add explanation for telnet login.	Peter LEE
Dec.13.2016.	2.6	○ Change Images of products ○ Correct some errors and expressions	Roy LEE
Aug.24.2018.	2.7	○ Improve the table 2-3 serial port (RJ45) ○ Add captions to all figures and tables ○ Move position of the caption for all tables ○ Add a description about the SD command for TELNET ○ Correct some errors and expressions	Roy LEE
Jul.28.2022.	2.8	○ Add a notification about FCC	Roy Lee
Aug.11.2022.	2.9	○ Updated URLs of websites ○ Removed the Components section ○ Removed the Related materials section	Roy LEE