

Serial ↔ LAN/WLAN Converter

CSC-H64 User Manual

Version 1.5



Sollae Systems Co., Ltd.

<https://www.ezTCP.com>



This symbol, found on your product or on its packaging, indicates that this product should not be treated as household waste when you wish to dispose of it. Instead, it should be handed over to an applicable collection point for the recycling of electrical and electronic equipment. By ensuring this product is disposed of correctly, you will help prevent potential negative consequences to the environment and human health, which could otherwise be caused by inappropriate disposal of this product. The recycling of materials will help to conserve natural resources. For more detailed information about the recycling of this product, please contact your local city office, household waste disposal service or the retail store where you purchased this product.

※ This equipment obtained certification by using 1.5M serial cable.

Note:

This equipment has been tested and found to comply with the limits for a Class A digital device, pursuant to part 15 of the FCC Rules. These limits are designed to provide reasonable protection against harmful interference when the equipment is operated in a commercial environment. This equipment generates, uses, and can radiate radio frequency energy and, if not installed and used in accordance with the instruction manual, may cause harmful interference to radio communications. Operation of this equipment in a residential area is likely to cause harmful interference in which case the user will be required to correct the interference at his own expense.

Contents

1	Overview	- 6 -
1.1	Overview	- 6 -
1.2	Features	- 6 -
1.3	Application Examples	- 7 -
1.3.1	Wired LAN	- 7 -
1.3.2	Wireless LAN	- 9 -
1.4	Specification	- 11 -
1.4.1	Hardware	- 11 -
1.4.2	Software	- 11 -
1.5	Dimensions	- 12 -
1.5.1	Dimensions	- 12 -
1.6	Interface	- 13 -
1.6.1	Panel Layout	- 13 -
1.6.2	LED	- 14 -
1.6.3	USB Setup Port for connection with a PC	- 14 -
1.6.4	Function Button (Func.)	- 14 -
1.6.5	Supplying Power	- 15 -
1.6.6	USB Host Port for Connection with WLAN adapter	- 15 -
1.6.7	Serial interface	- 16 -
1.6.8	Ethernet interface	- 18 -
2	Installation and Test	- 19 -
2.1	Network Mode	- 19 -
2.1.1	Wired LAN mode	- 19 -
2.1.2	Wireless LAN Mode	- 19 -
2.2	WLAN overview	- 20 -
2.2.1	Infrastructure	- 20 -
2.2.2	Ad-hoc	- 21 -
2.2.3	Soft AP	- 22 -
2.2.4	Key terms	- 23 -
2.2.5	Authentication and Security	- 23 -
2.3	Installation	- 24 -
2.3.1	Connection	- 24 -
2.3.2	Setting Network Aera	- 25 -
2.4	Simple Test	- 27 -

3	Configuration	- 30 -
3.1	Connecting to CSC-H64	- 30 -
3.1.1	Setting by Wireless LAN	- 30 -
3.1.2	Setting by wired LAN	- 32 -
3.1.3	Setting by USB port	- 33 -
3.2	AT command.....	- 35 -
4	Operation Mode	- 36 -
4.1	What is the Operation Mode?.....	- 36 -
4.2	How to entering each mode.....	- 36 -
4.3	Comparison of each mode.....	- 37 -
4.4	Normal Mode.....	- 37 -
4.5	Button Setup Mode.....	- 38 -
4.6	ISP Mode	- 38 -
5	Communication Mode.....	- 39 -
5.1	TCP Server.....	- 39 -
5.1.1	Key parameters.....	- 39 -
5.1.2	Examples.....	- 40 -
5.2	TCP Client.....	- 43 -
5.2.1	Key parameters.....	- 43 -
5.2.2	Examples.....	- 44 -
5.3	AT Command.....	- 47 -
5.3.1	Key parameters.....	- 47 -
5.3.2	Examples.....	- 48 -
5.4	UDP.....	- 51 -
5.4.1	Key parameters.....	- 51 -
5.4.2	Examples.....	- 52 -
6	System Management.....	- 54 -
6.1	Upgrading Firmware.....	- 54 -
6.1.1	Firmware	- 54 -
6.1.2	Processes.....	- 54 -
6.2	Status Monitoring.....	- 56 -
6.2.1	Using TELNET.....	- 56 -
6.2.2	Using ezManager.....	- 59 -
7	Security Functions.....	- 63 -
7.1	SSL.....	- 63 -

7.1.1	What is the SSL(Secure Socekt Layer)?	- 63 -
7.1.2	How to set the SSL.....	- 63 -
7.1.3	Restriction.....	- 64 -
7.2	Security	- 65 -
7.2.1	Access Restriction (ezTCP Firewall).....	- 65 -
7.2.2	Setting Password.....	- 65 -
7.2.3	Using WEP	- 66 -
7.2.4	Using WPA-PSK	- 66 -
7.2.5	Using WPA-Enterprise.....	- 67 -
7.2.6	Advanced Settings	- 69 -
8	Additional Functions.....	- 70 -
8.1	Option Tab Functions.....	- 70 -
8.1.1	Notify IPv4 Change.....	- 70 -
8.1.2	Sending MAC Address	- 71 -
8.2	Serial Port Tab Functions.....	- 72 -
8.2.1	TCP Server / Client mode - ①	- 72 -
8.2.2	Separator - ②.....	- 73 -
8.2.3	TELNET COM port Control Option (RFC 2217) - ③.....	- 73 -
8.2.4	Disable TCP Transmission Delay - ④	- 73 -
8.2.5	SSL - ⑤	- 73 -
8.1	Additional Functions.....	- 74 -
8.1.1	Factory Reset	- 74 -
9	Checklist in Trouble.....	- 75 -
9.1	Connection Problem over TCP/IP.....	- 75 -
9.2	Data Communication Problem on the Serial Port	- 76 -
10	Technical Support and Warranty.....	- 77 -
10.1	Technical Support	- 77 -
10.2	Warranty.....	- 77 -
10.2.1	Refund.....	- 77 -
10.2.2	Free Repair Services	- 77 -
10.2.3	Charged Repair Services.....	- 77 -
11	Precaution and Exemption from Liability.....	- 78 -
11.1	Precaution.....	- 78 -
11.2	Exemption from Liability.....	- 79 -
11.2.1	English version.....	- 79 -

11.2.2 French version - 80 -

12 Revision History..... - 82 -

1 Overview

1.1 Overview

CSC-H64 is a serial to Ethernet/WLAN converter that enables your serial devices to carry robust networking capabilities. This serial to Ethernet/WLAN converter offers 4 serial ports interfaced with RS232/RS422/RS485 and a frame delimiter for packet fragmentation.

CSC-H64 comes preloaded with Soft AP so it can simply be linked to any devices with WLAN by operating as an AP. It eases network construction with mobile devices such as smartphones, tablet PCs and laptops where an AP is unavailable.

Ensuring reliable operation with industrial temperature range of $-40^{\circ}\text{C}\sim+85^{\circ}\text{C}$ (without a USB WLAN adapter), along with an overvoltage, reverse voltage and overcurrent protection circuit, makes this Serial to Ethernet/WLAN converter suitable for harsh industrial environments.

To connect CSC-H64 to wireless LAN, a USB wireless LAN adapter which uses a RT3070/RT5370 chipset of Ralink Corporation is required.

1.2 Features

- Serial to Ethernet and Wireless LAN(IEEE 802.11 b/g) converter
- IPv4 / IPv6 dual stack
- 4 X RS232/RS422/RS485 (D-SUB 9 pin Male, up to 230,400bps)
- Infrastructure and Ad-hoc network
- Soft AP (setting and connection through a smartphone or laptop without an AP available)
- Security options (Password, SSL, WEP, WPA-PSK, WPA2-PSK)
- WPA Enterprise (EAP-TLS, EAP-TTLS, PEAP)
- Variety of monitoring status (ezManager, Telnet)
- Industrial temperature range ($-40^{\circ}\text{C}\sim+85^{\circ}\text{C}$, without a USB WLAN adapter)

1.3 Application Examples

1.3.1 Wired LAN

- 1:1 Connection with a PC

● RS232/422/485
● LAN



Figure 1-1 1:1 connection with a PC

- Multiple serial ports

● RS232/422/485
● LAN

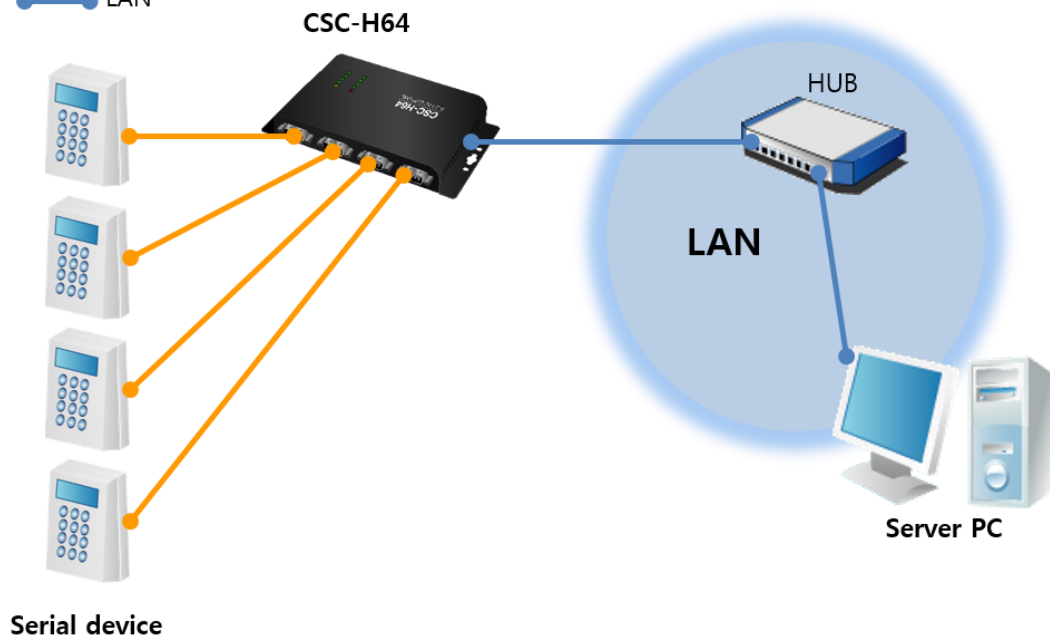

Figure 1-2 multiple serial ports

- Applied to LAN
- RS232/422/485
- LAN

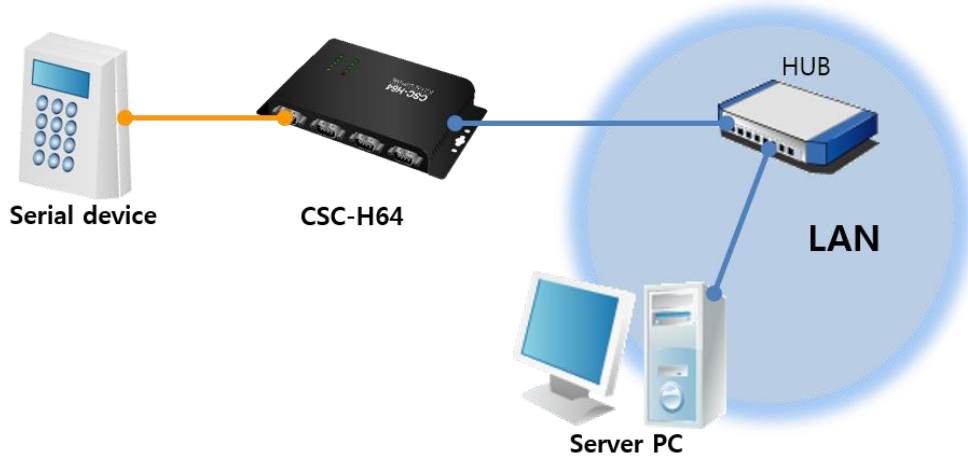

Figure 1-3 applied to LAN

- Applied to the Internet with an IP Share Router

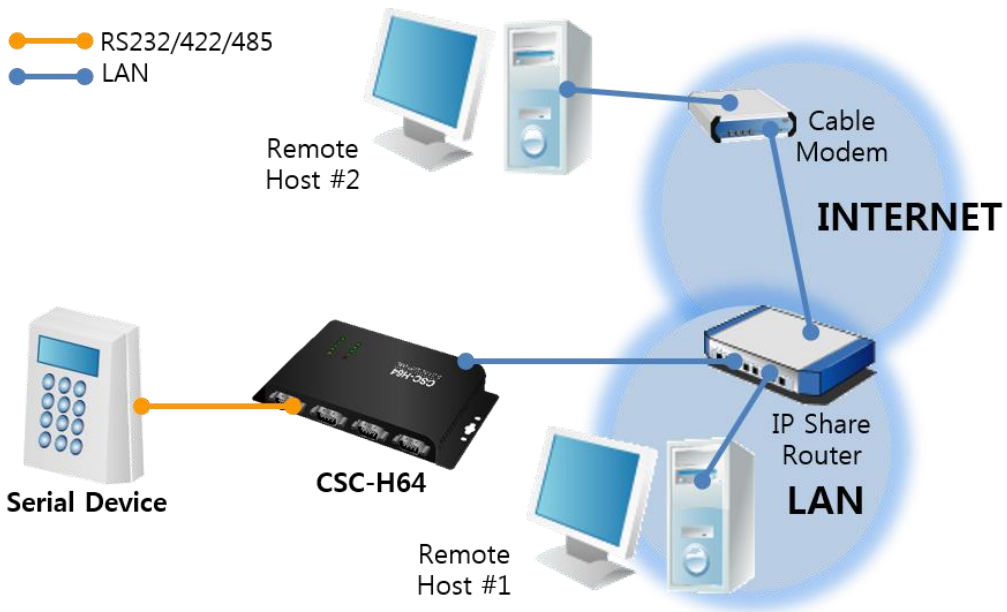

Figure 1-4 applied to the Internet with an IP share router

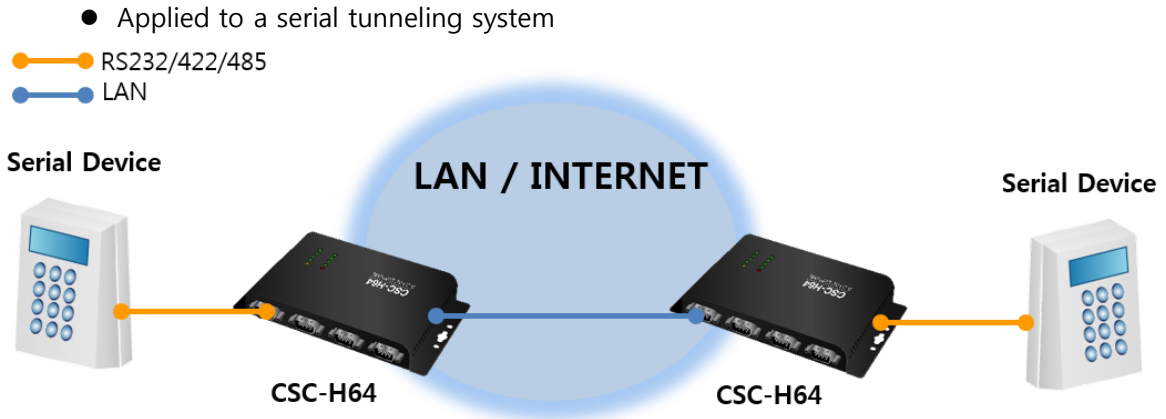

Figure 1-5 applied to a serial tunneling system

1.3.2 Wireless LAN

- 1:1 network with a PC

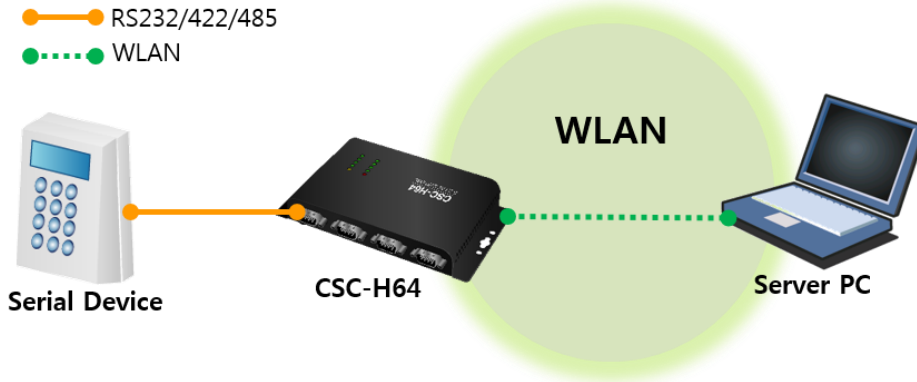

Figure 1-6 1:1 network with a PC

- 1:1 network with a PC through an AP

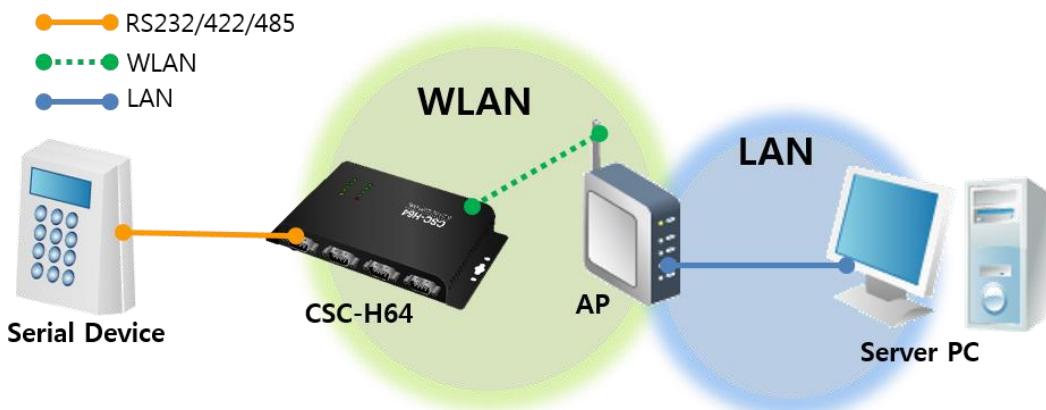

Figure 1-7 1:1 network with a PC through an AP

- Internet connection with a xDSL/cable modem

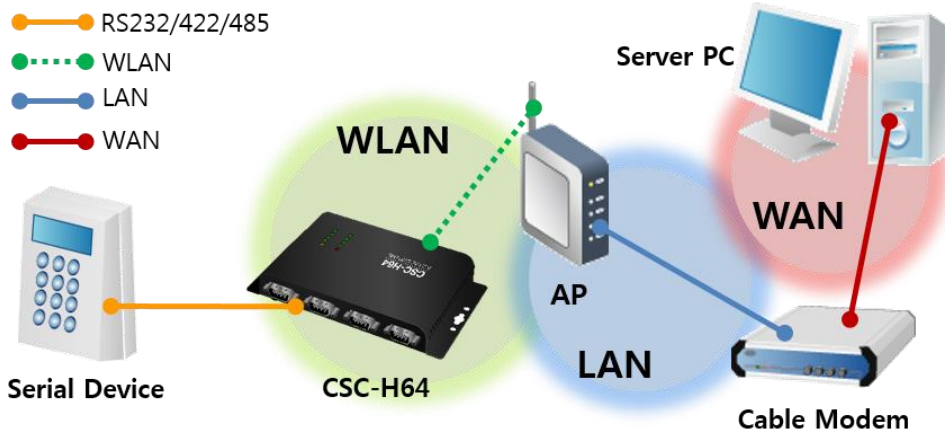

Figure 1-8 Internet connection with an xDSL/cable modem

1.4 Specification

1.4.1 Hardware

Power	Input Voltage	DC 5V ($\pm 0.5V$) / USB
	Current	Typically, 235mA (without a USB WLAN adapter)
Dimension		180mm x 90mm x 24mm
Weight		About 417g (without a USB WLAN adapter)
Interface	Serial	4 x RS232/422/485 (300bps ~ 230,400bps)
	Network	10 Base-T / 100 Base-TX Ethernet Auto MDI/MDIX (cable auto-sensing)
	USB	IEEE802.11b/g (Ralink RT3070/5370 chipset wireless adaptor required)
Temperature	Operating / Storage	-40 ~ 85°C (without a USB WLAN adapter)
Approval		KC, CE, FCC
RoHS		RoHS Compliant

Table 1-1 hardware specification

1.4.2 Software

Protocol	TCP, UDP, IPv4/IPv6 dual stack, ICMPv6/TCPv6/UDPv6, ICMP, ARP, DHCP, PPPoE, DNS, DDNS(Dynamic DNS), Telnet, Telnet COM Port Control Option (RFC2217), SSL	
Operation mode	Normal	For Normal Data Communication
	ISP	For Upgrading F/W
	Button setup	For Configuration via USB port or WLAN
Communication mode	TCP Server	TCP Passive Connection
	TCP Client	TCP Active Connection
	AT Command	TCP Passive / Active Connection
	UDP	UDP
Major Utilities	ezManager	Configuration Utility for MS Windows (Supports Downloading F/W)
	ezVSP	Serial to TCP/IP Virtual driver for MS Windows

Table 1-2 software specification

1.5 Dimensions

1.5.1 Dimensions

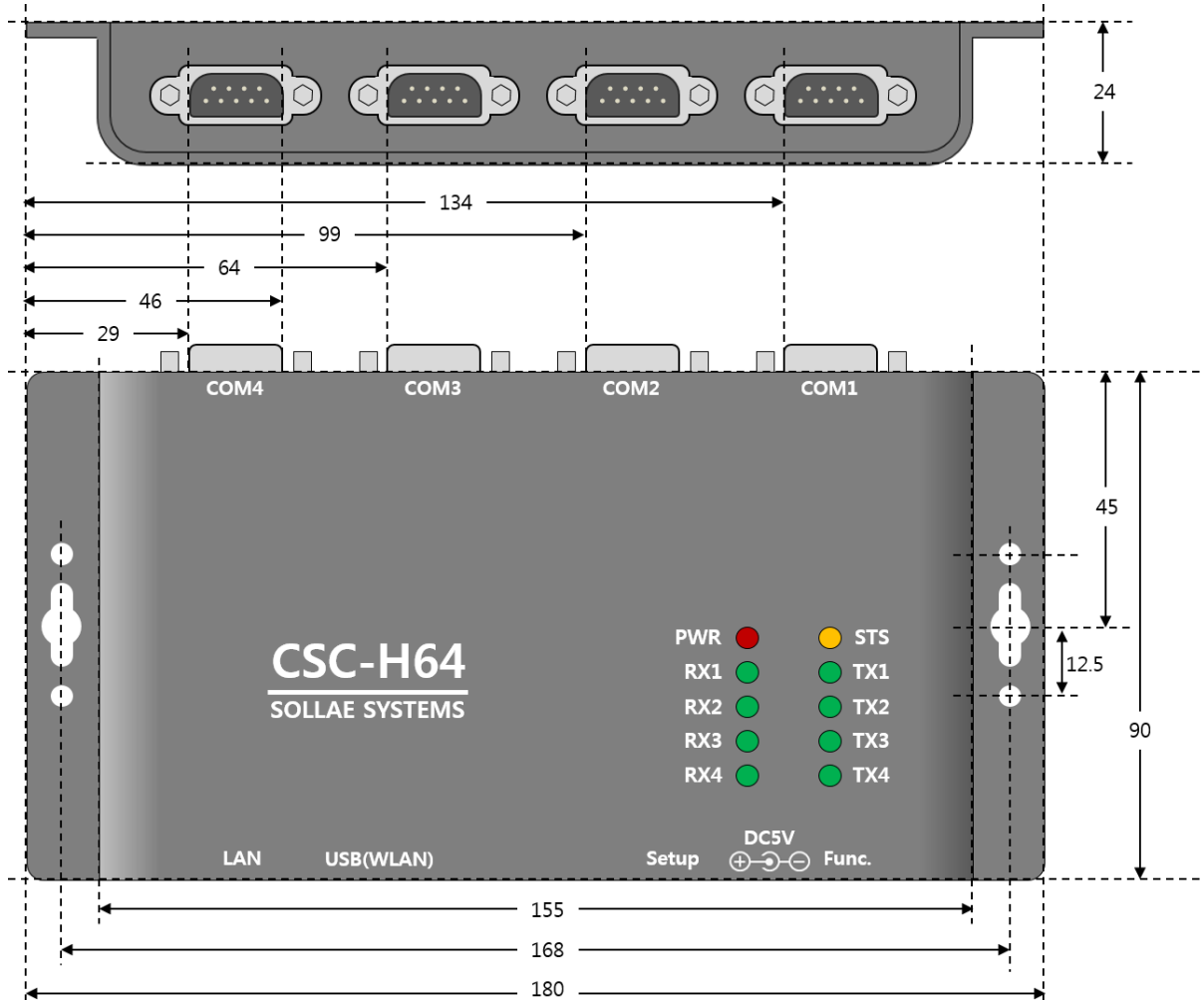

Figure 1-9 dimensions

Dimensions may vary according to a method of measurement.

1.6 Interface

1.6.1 Panel Layout

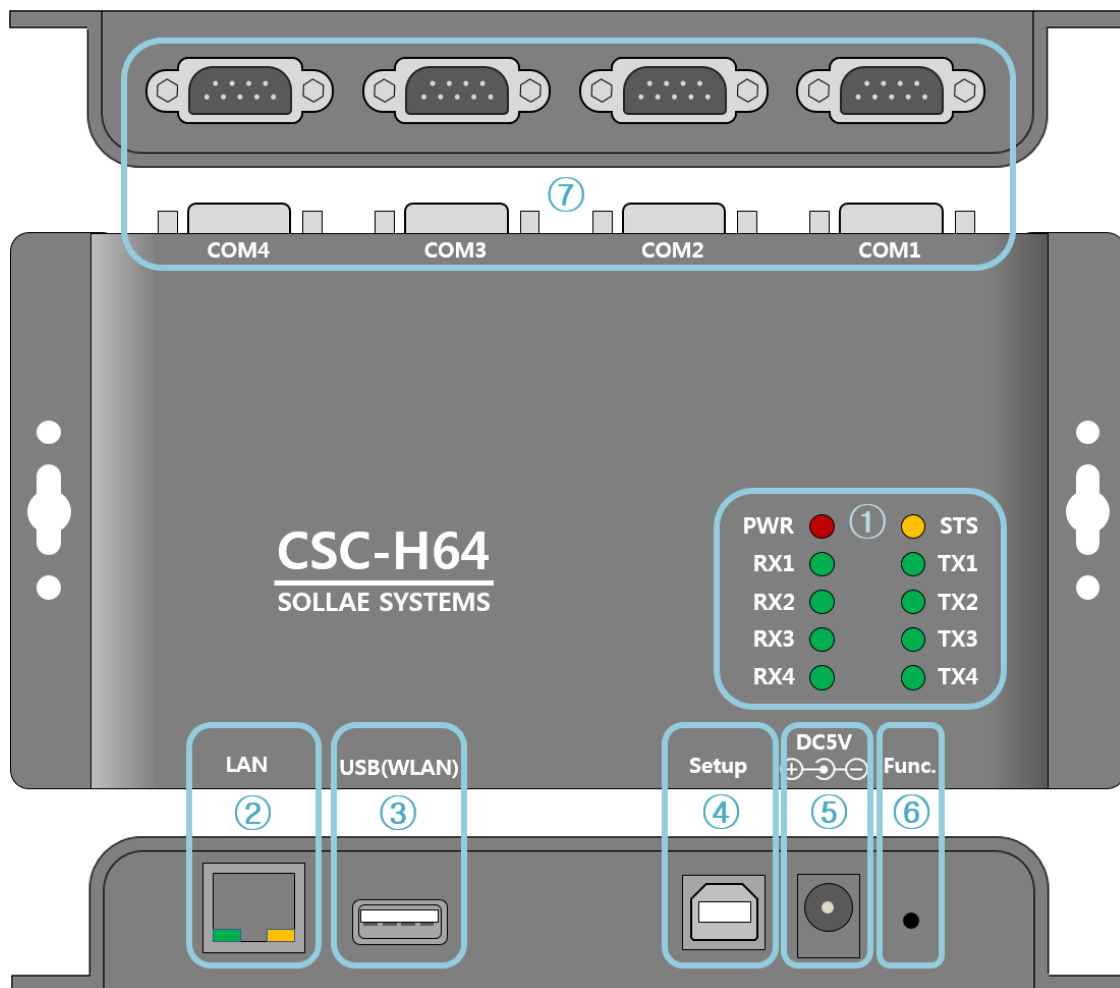

Figure 1-10 panel layout

- ① LED: PWR, STS, TX, RX
- ② Ethernet port: 10/100M
- ③ USB Host port: USB Wireless LAN adaptor connection
- ④ USB Setup port: For connecting to ezManager
- ⑤ Power port (DC 5V)
- ⑥ Function port (Func.)
- ⑦ Serial port: RS232 / RS422 / RS485

1.6.2 LED

Mode	Name	Color	Status	Description
Power	PWR	Red	On	Supplying the power
Normal mode	TX1~4	Green	Blinks	Sending data to serial port
		Green	On	Connecting with TCP
	RX1~4	Green	Blinks	Receiving data from serial port
		Green	On	Connecting with TCP
	STS	Yellow	Blinks in every second	Obtaining an IP address
			Blinks 4 times at once	Without obtaining an IP address under DHCP or PPPoE network
ISP mode	STS	Yellow	Off	Entering ISP mode
Button Setup mode	STS	Yellow	Blinks simultaneously	Entering Button Setup mode
	TX1~4	Green		
	RX1~4	Green		

Table 1-3 LED status on the top panel

☞ ***Please refer to the [Table 9-1 LED status according to symptoms] for LED pattern when there is a problem on CSC-H64.***

1.6.3 USB Setup Port for connection with a PC

USB setup port is for connection with a PC. You can access to CSC-H64 via ezManager after connecting a USB cable to this port. Moreover, you can supply DC 5V power to CSC-H64 through this port.

1.6.4 Function Button (Func.)

If this button is pressed, CSC-H64 operates in Button setup mode. This mode is used for factory reset and setting parameters through Wireless LAN or USB port.

1.6.5 Supplying Power

CSC-H64 provides the following two ports for supplying power. You can choose one of the two options.

- Power port

The Power port uses DC 5V and its specification is as follows:

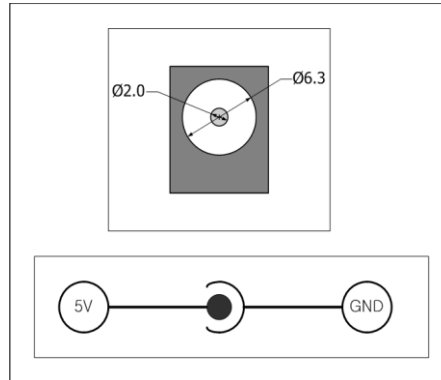

Figure 1-11 specification of power port

- USB device port (Setup Port)

You can supply DC 5V power through this port. Note that unstable operation may be occurred in case of supplying power via this port due to insufficient current.

1.6.6 USB Host Port for Connection with WLAN adapter

CSC-H64 provides a USB host port for a USB WLAN adapter. You can connect CSC-H64 to Wireless LAN by connecting the WLAN adapter to this port.

☞ **Caution: Only adapters using Ralink RT3070/5370 chipsets are available.**

☞ **Caution: WLAN cannot be used with Ethernet at the same time.**

1.6.7 Serial interface

CSC-H64 provides four serial ports interfaced with D-SUB 9 pin male connectors and you can select the type among RS232, RS422 or RS485.

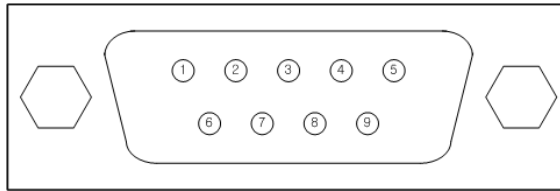

Figure 1-12 D-SUB 9 pin male connector

- Pin Assignment in RS232

Number	Name	Description	Level	I/O	Wiring
1	-	-	-	-	-
2	RXD	Receive Data	RS232	IN	Required
3	TXD	Transmit Data	RS232	OUT	Required
4	DTR	Data Terminal Ready (always output active signal)	RS232	OUT	Optional
5	GND	Ground	Ground	-	Required
6	-	-	-	-	-
7	RTS	Request To Send	RS232	OUT	Optional
8	CTS	Clear To Send	RS232	IN	Optional
9	-	-	-	-	-

Table 1-4 pin assignment in RS232

- Pin Assignment in RS422

Number	Name	Description	Level	I/O	Wiring
1	TX -	Transmit Data -	RS422	OUT	Required
2	-	-	-	-	-
3	RX -	Receive Data -	RS422	IN	Required
4	RX +	Receive Data +	RS422	IN	Required
5	GND	Ground	Ground	-	Required
6	-	-	-	-	-
7	-	-	-	-	-
8	-	-	-	-	-
9	TX +	Transmit Data +	RS422	OUT	Required

Table 1-5 pin assignment in RS422

- Pin Assignment in RS485

Number	Name	Description	Level	I/O	Wiring
1	TRX -	Data -	RS485	IN/OUT	Required
2	-	-	-	-	-
3					
4					
5	GND	Ground	Ground	-	Required
6	-	-	-	-	-
7	-	-	-	-	-
8	-	-	-	-	-
9	TRX +	Data +	RS485	IN/OUT	Required

Table 1-6 pin assignment in RS485

- Serial Port Specification

Parameter	Value
The number of port	4
Serial type	RS232 / RS422 / RS485
Baud rate	300 ~ 230,400 [bps]
Parity	NONE / EVEN / ODD / MARK / SPACE
Data bit	8 / 7 (7 data bit is only available on using Parity)
Stop bit	1 / 1.5 / 2
Flow control	NONE, RTS/CTS, Xon/Xoff

Table 1-7 serial port parameters

1.6.8 Ethernet interface

CSC-H64 has an Ethernet port which supports 10/100M bit Ethernet. Both direct and cross over cable can be used because it automatically detects the type of cable.



Figure 1-13 Ethernet connector interface (RJ45)

- Ethernet port interface (RJ45)

Number	Name	I/O
1	TX+	Out
2	TX-	Out
3	RX+	In
4	-	-
5	-	-
6	RX-	In
7	-	-
8	-	-

Table 1-8 RJ45 the Ethernet port interface

- LED indicator of RJ45

Color	LED status	Description
Green	On	Connected to network
	Off	Not connected to network
	Blink	Receiving or transmitting network data
Yellow	On	Connected to 100M Ethernet
	Off	Connected to 10M Ethernet

Table 1-9 LED indicator of RJ45

2 Installation and Test

2.1 Network Mode

2.1.1 Wired LAN mode

CSC-H64 operates in LAN mode when you connect a LAN cable. To use this mode, you are required to either remove a USB wireless LAN adapter or set WLAN disabled.



Figure 2-1 Ethernet connection

2.1.2 Wireless LAN Mode

If the USB WLAN adapter is connected, CSC-H64 operates in WLAN mode.

CSC-H64 supports IEEE802.11b/g. IEEE802.11 standard that is called Wi-Fi has three network topologies: Infrastructure, Ad-hoc and Soft AP mode.

For security, CSC-H64 supports WEP, WPA-PSK and WPA-Enterprise (EAP-TLS/TTLS, PEAP).

☞ ***To connect CSC-H64 to wireless LAN, a USB wireless LAN adapter which uses a RT3070/RT5370 chipset of Ralink Corporation is required.***

2.2 WLAN overview

2.2.1 Infrastructure

In this mode, every wireless LAN station communicates through an Access Point (AP), which is able to interface with both Wireless LAN and Ethernet, so that all stations can be connected to Ethernet.

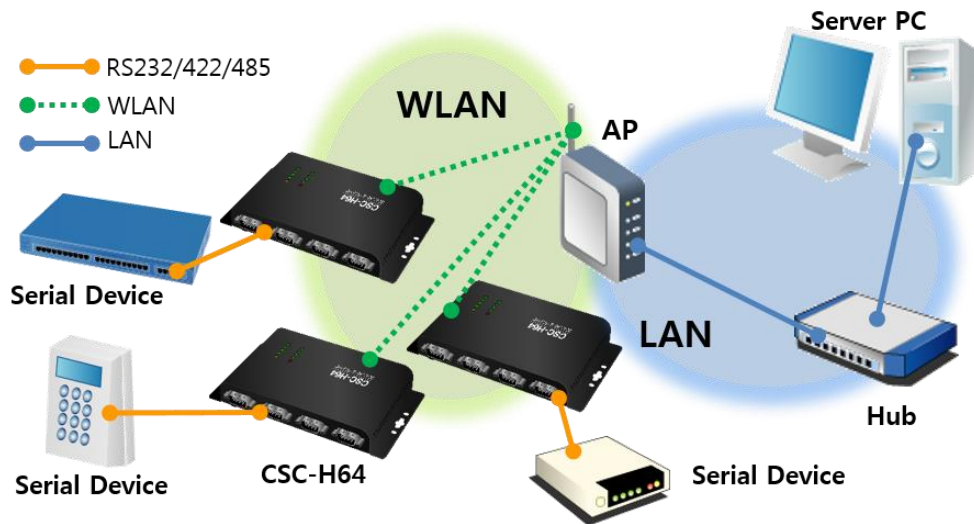

Figure 2-2 infrastructure mode

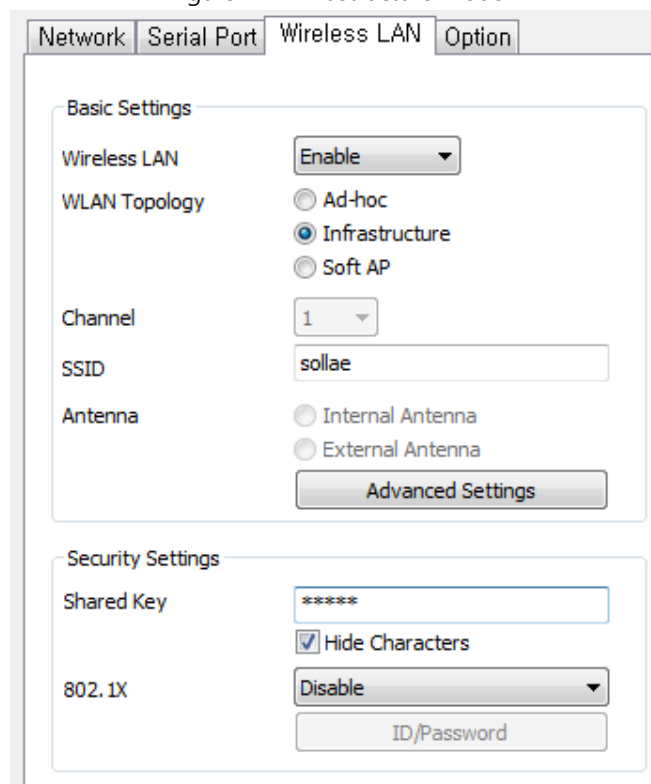

Figure 2-3 setting of Infrastructure

2.2.2 Ad-hoc

This is an easy way to set up network since wireless LAN stations communicate each other without an AP in this mode. It is suitable for a small-scale network if wired LAN is not available. Usually, it is called peer-to-peer mode.

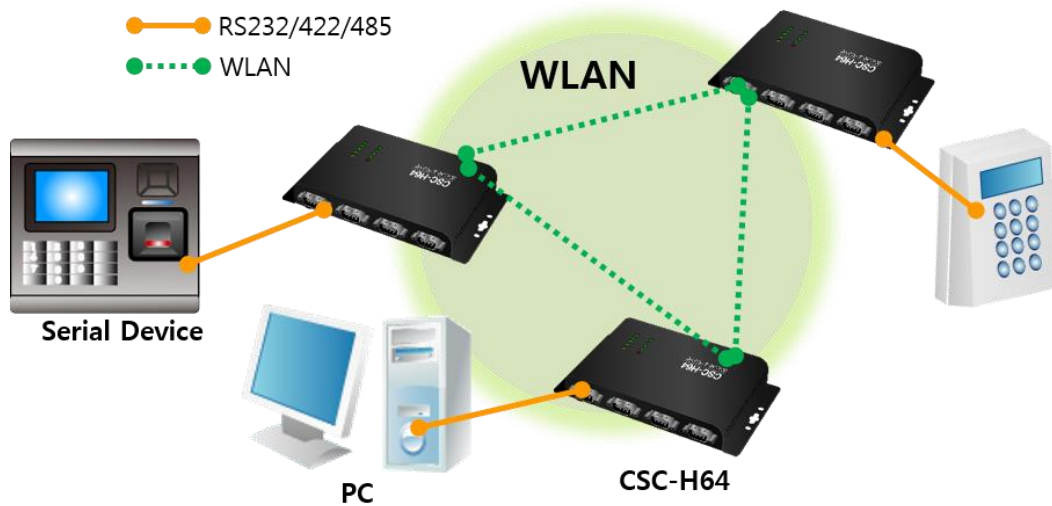

Figure 2-4 Ad-hoc mode

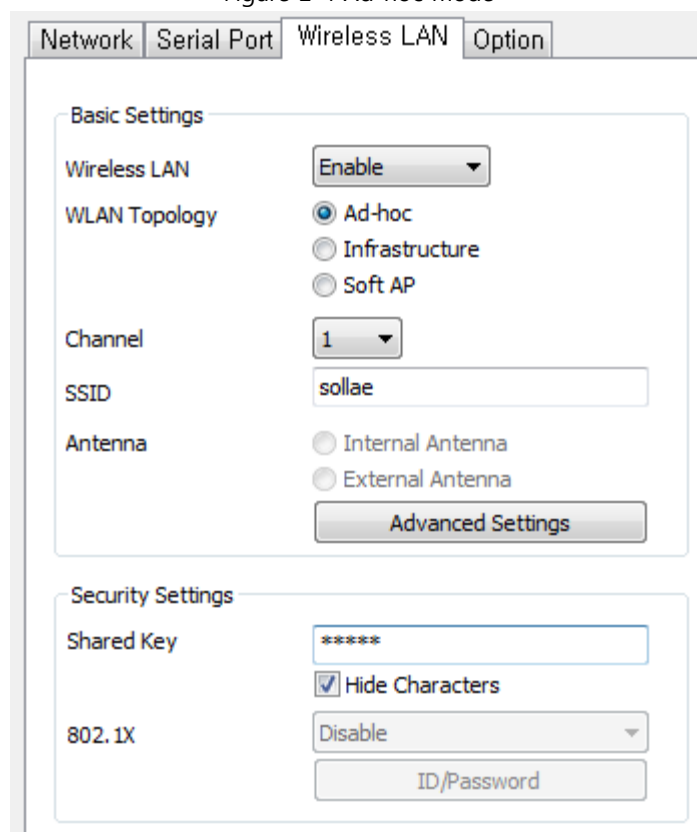

Figure 2-5 setting of Ad-hoc

2.2.3 Soft AP

Soft AP (Software embedded Access Point) is a mode that a wireless client can act as an AP through software embedded AP functions. Using this mode, the wireless client allows you to communicate with not only laptops and smartphones but also devices without Ad-hoc function.

CSC-H64 supports Soft AP function. While operating in this function, it has 10.1.0.1 as its IP address and assigns one of 10.1.X.X IP addresses to each client. (A simple DHCP server)

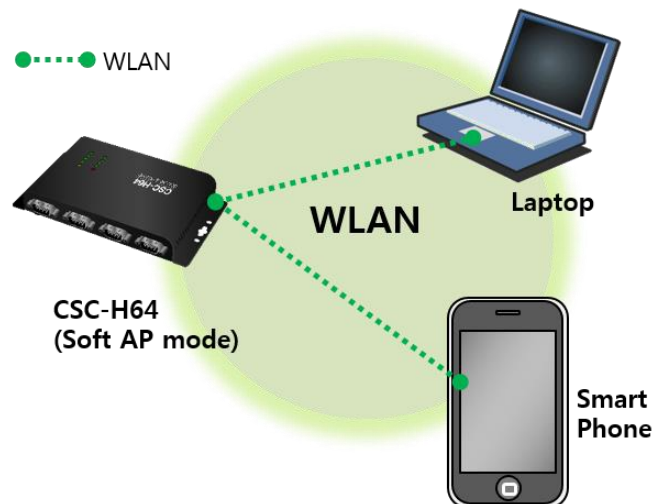

Figure 2-6 Soft AP mode

You can set Soft AP function manually on [Wireless LAN] section like the figure below.

The screenshot shows a configuration window with tabs for 'Network', 'Serial Port', 'Wireless LAN', and 'Option'. The 'Wireless LAN' tab is active. Under 'Basic Settings', 'Wireless LAN' is set to 'Enable', 'WLAN Topology' is set to 'Soft AP' (selected with a radio button), 'Channel' is '1', 'SSID' is 'sollae', and 'Antenna' is set to 'Internal Antenna'. An 'Advanced Settings' button is visible. Under 'Security Settings', 'Shared Key' is masked with asterisks, 'Hide Characters' is checked, and '802.1X' is set to 'Disable'. An 'ID/Password' button is also present.

Figure 2-7 setting of Soft AP

2.2.4 Key terms

- SSID(Service Set Identifier)

It is a name to identify the particular wireless LAN. So, every single station should have the same SSID to communicate in the network. In the case of infrastructure mode, you have to set the same SSID of an AP to CSC-H64. Otherwise, it will not communicate at all. The maximum length of this parameter is 31 bytes and the default is "sollae".

- Channel

Wireless LAN stations communicate through the ISM (Industrial, Scientific, and Medical) band which has the range of frequencies around 2.4GHz. IEEE 802.11 specification divides this band into 14 channels in every 5MHz. If you install more than one wireless network in the same area, the channels should be set more than 4 channels apart to avoid interferences.

2.2.5 Authentication and Security

- Authentication

A wireless LAN station should get authentication from the AP in the infrastructure network. There are two methods for the authentication, Open System and Shared Key.

- WEP (Wired Equivalent Privacy)

The WEP is a security protocol for wireless LAN. You need to set 64-bit or 128-bit key. You can use both hexadecimal and ASCII code for this.

- WPA (Wi-Fi Protected Access)

WPA is a security standard for users of devices equipped with Wi-Fi wireless connection. It is expected to replace the original Wi-Fi security standard, Wired Equivalent Privacy (WEP), compensating the weakness of it. There are two modes about the user authentication in WPA security. One is Enterprise which has an authentication server and the other is PSK (Pre-Shared Key) which does not have any servers.

- WPA2

As final security of Wireless LAN, The Counter Mode with Cipher Block Changing Message Authentication Code Protocol (CCMP) was suggested for IEEE80211i (Wireless LAN standard) to replace the TKIP. CCMP uses Advanced Encryption Standard (AES) which is adopted by WPA2. WPA 2 has also both Enterprise and PSK mode.

2.3 Installation

2.3.1 Connection

- Wired LAN

Before testing CSC-H64, users should connect both serial and Ethernet port to a PC. It will be no problem that the Ethernet connection includes network hubs.



Figure 2-8 connection between CSC-H64 and a PC

- Wireless LAN

Make sure that a connection between your PC and CSC-H64 is established via Serial and wireless LAN. This section is an example which is based on Infrastructure mode.

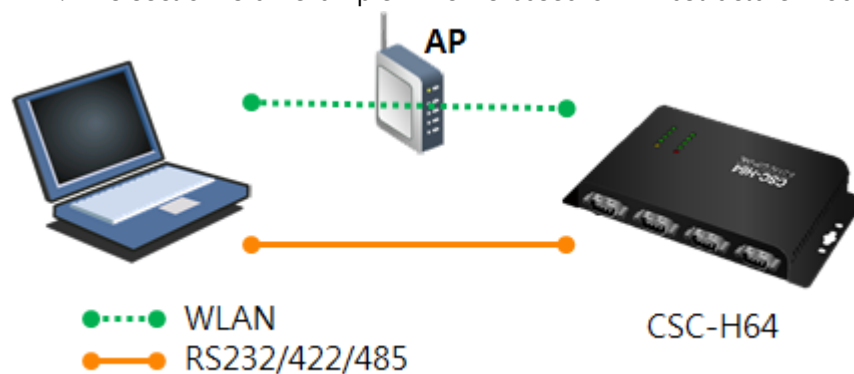

Figure 2-9 WLAN and serial connection with a laptop

For the first-time connection to WLAN, please refer to 3.1.1 Setting by Wireless LAN or 3.1.3 Setting by USB port.

☞ *In case if your PC doesn't have a RS232 port, use a USB to RS232 cable.*

2.3.2 Setting Network Aera

This step is for setting both CSC-H64 and users' PC to be located the same network. If there is nothing other than them, the TCP connection between CSC-H64 and users' PC can be established.

- Setting of the PC

Add or change the IP address of the network adapter on your PC like the following. Get into the menu of [Windows Control Panel] >> [Network Connections] >> [Properties of the Network Adapter – with right click of your mouse]. Then, you can see the properties of [Internet Protocol (TCP/IP)] and press the [Advanced..] button for adding an IP Address like the figure below.

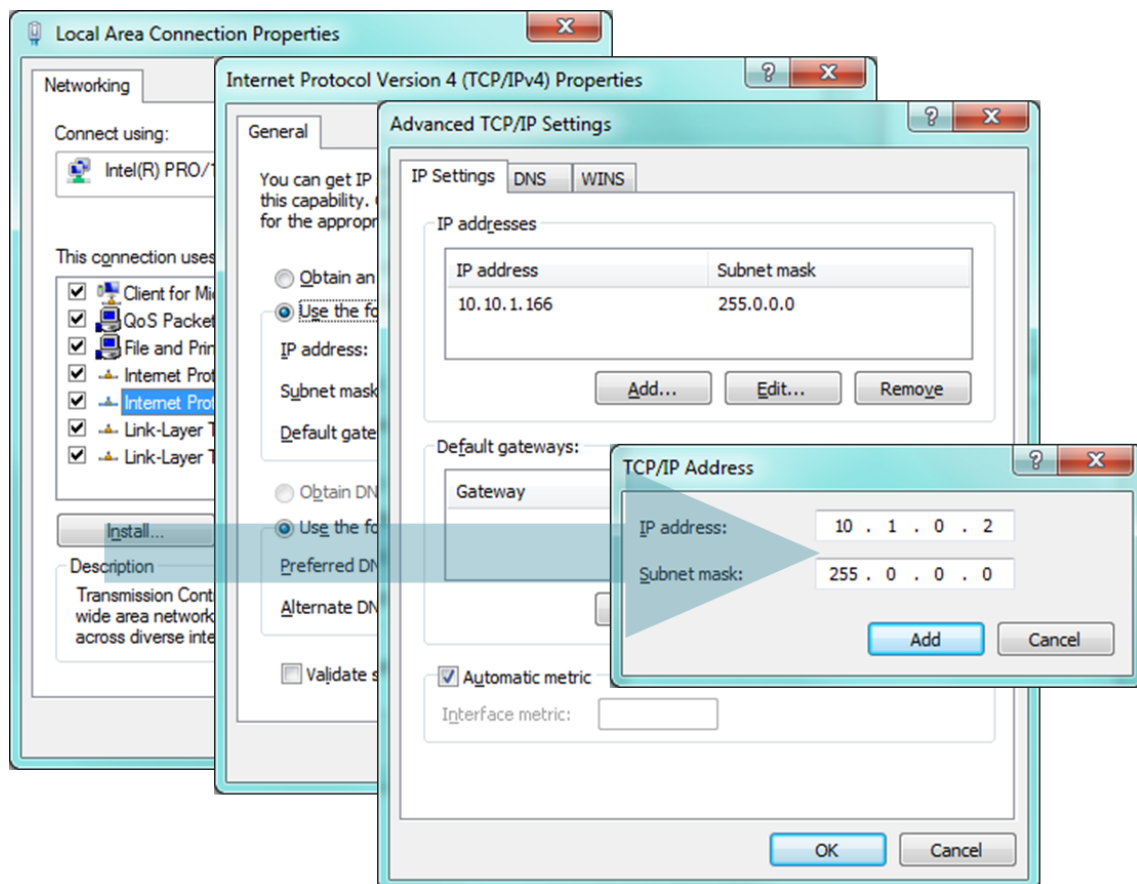

Figure 2-10 adding / changing the IP address of users' PC

- Setting of CSC-H64

CSC-H64 uses ezManager as it's a configuration program. ezManager is for MS Windows, and this is comfortable to use because it does not need installation. Firstly, search your CSC-H64 via network. All the values of parameters have been set to the default values in the factory. To apply it to your system, proper values should be set via ezManager. Major parameters' default values are listed on below table. To implement this simple test, keep these values without any changes.

Name		Default Values
Network	Local IP Address	10.1.0.1
	Subnet Mask	255.0.0.0
	IPv6	Disable
Option	TELNET	Checked
	IP Address Search	Checked
Serial Port (COM1)	Serial Type	RS232
	Baud Rate	19,200bps
	Parity	NONE
	Data Bits	8
	Stop Bit	1
	Communication mode	TCP Server
	Local Port	14700

Table 2-1 default values of Major parameters

☞ *Visit our website for more details of ezManager.*

2.4 Simple Test

If you press the [Simple Test] button, test program will be shown on your screen.

- Connecting to the CSC-H64 via LAN

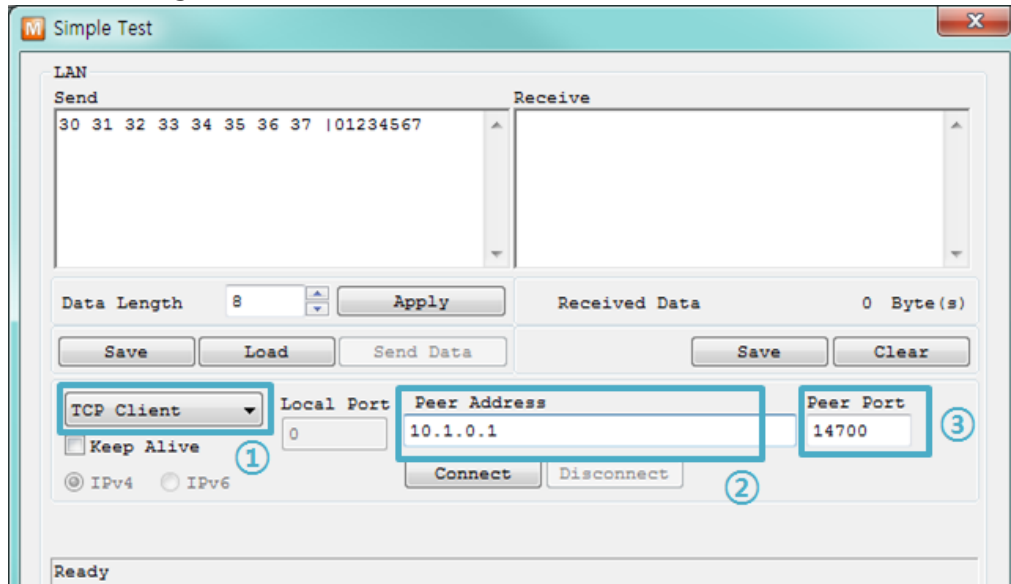

Figure 2-11 settings for TCP connection

- ① Select [TCP Client]
- ② Input a correct IP address and a port number of CSC-H64
- ③ Click the [Connect] button. (In case of TCP Server, it will be [Listen] button)

- Opening a RS232 Port

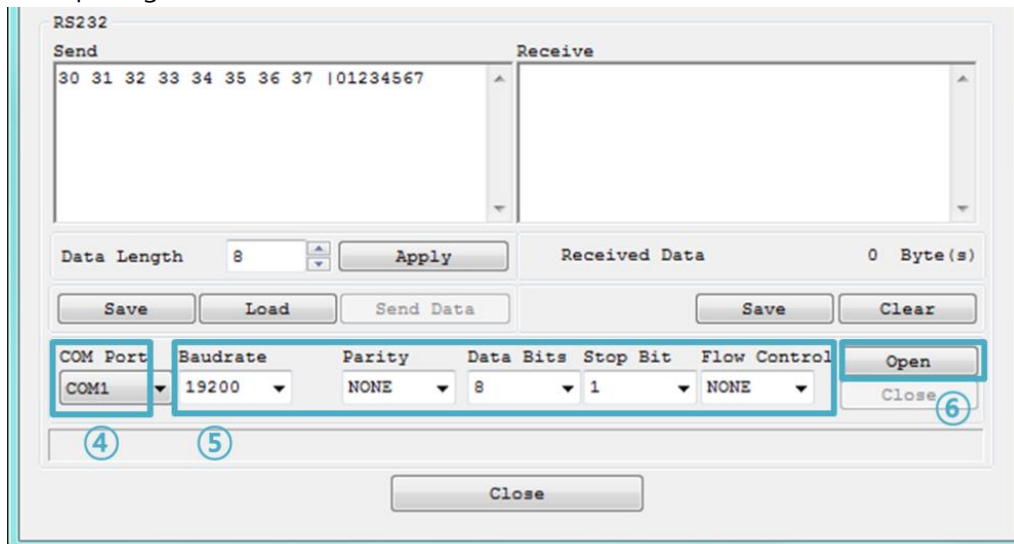

Figure 2-12 opening COM Port

- ④ Select a COM port which CSC-H64 is connected to
- ⑤ Make sure that all the parameters are the same with CSC-H64
- ⑥ Press the [Open] button

- Confirm the TCP Connection and COM port status

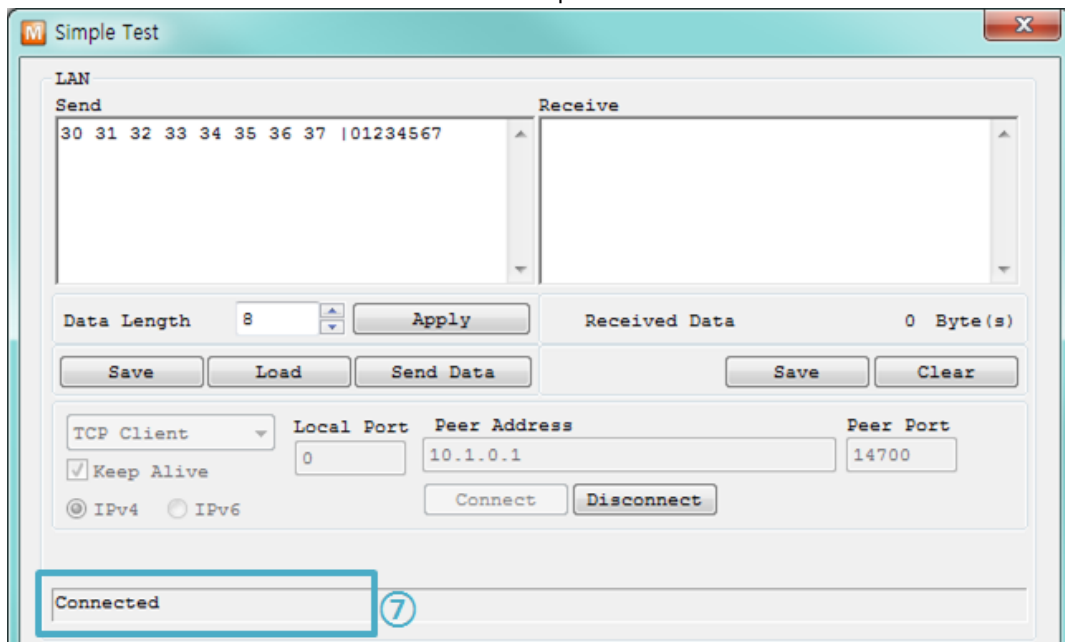

Figure 2-13 TCP Connected message

- ⑦ Press Check the message if the TCP connection has been established.

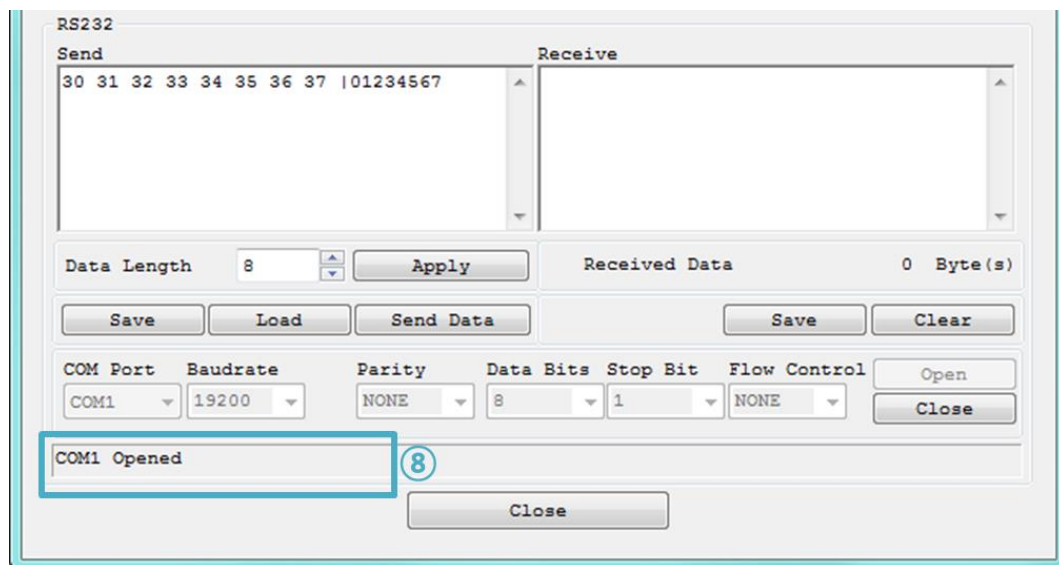

Figure 2-14 COM Port open message

- ⑧ Check the message if the COM port has been opened

● Data transmission test

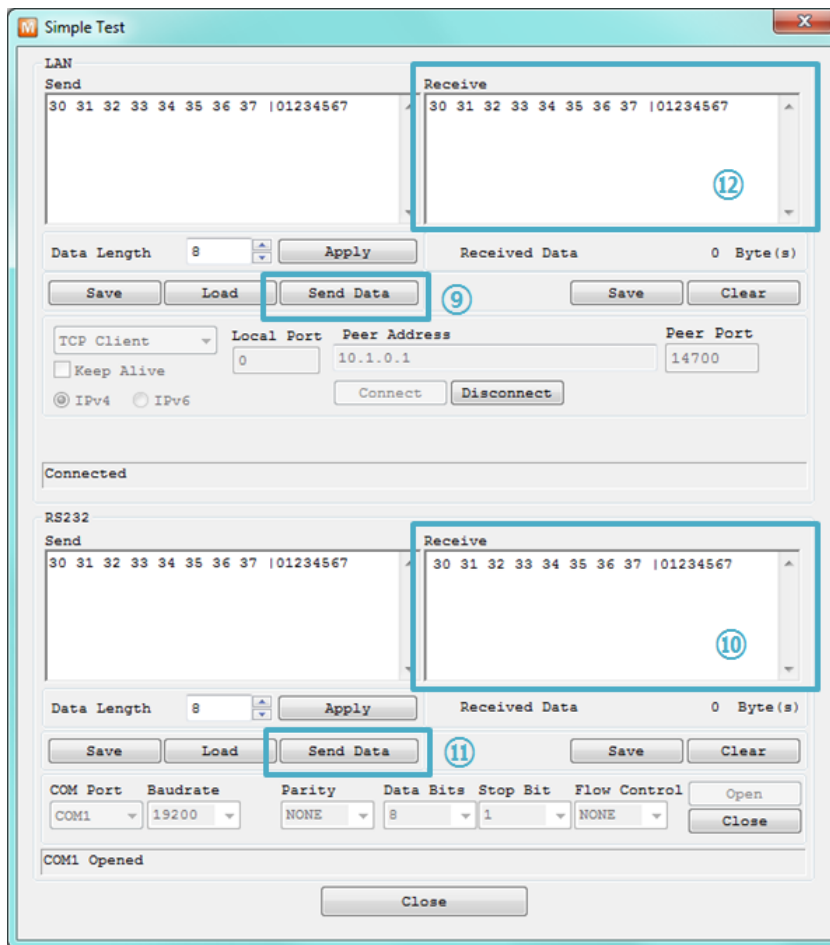

Figure 2-15 successful data transmission

- ⑨ Click the [Send data] on the LAN part
- ⑩ Check the data has been shown from the step ⑨

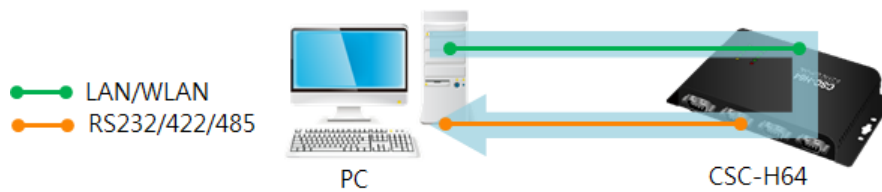

Figure 2-16 LAN → RS232

- ⑪ Press the [Send data] on the RS232 part
- ⑫ Check the data has been received from the step ⑪

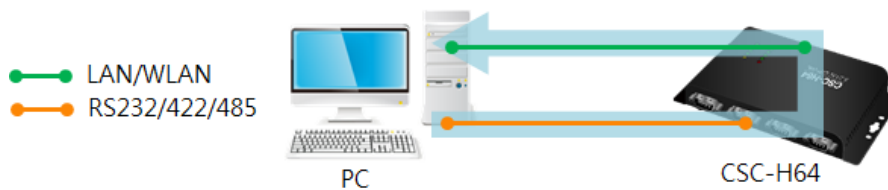

Figure 2-17 RS232 → LAN

3 Configuration

3.1 Connecting to CSC-H64

3.1.1 Setting by Wireless LAN

Button setup mode allows you to set parameters through wireless LAN as follows:

- ① Connecting to a USB WLAN adapter.
- ② Supplying power.
- ③ Entering button setup mode.

Push the Function(Func.) button shortly. RX, TX and STS LEDs will be blink.

- ④ Connecting to Wireless LAN using Soft AP.

Connect your laptop or smartphone to Wireless LAN (Wi-Fi) network using CSC-H64's Soft AP function. The SSID is "cfg_MAC Address's last 6 digit". (e.g. cfg_00:00:01)

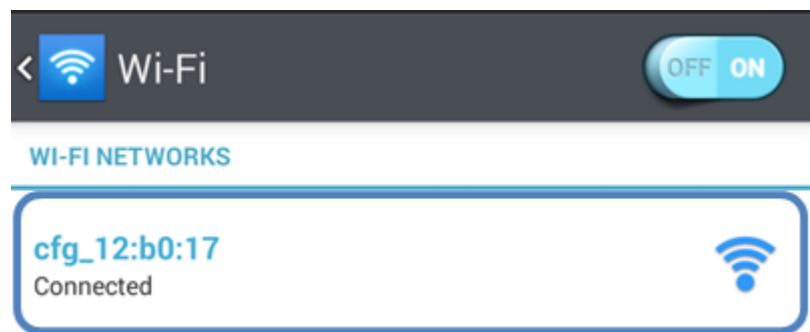

Figure 3-1 connecting Wireless LAN using Soft AP

- ⑤ Connecting to Web configuration page
After connection, CSC-H64 has 10.1.0.1 as its IP address and assigns one of 10.1.X.X IP addresses to each client. Run a web browser and connect to 10.1.0.1. Set proper WLAN parameters on the page.

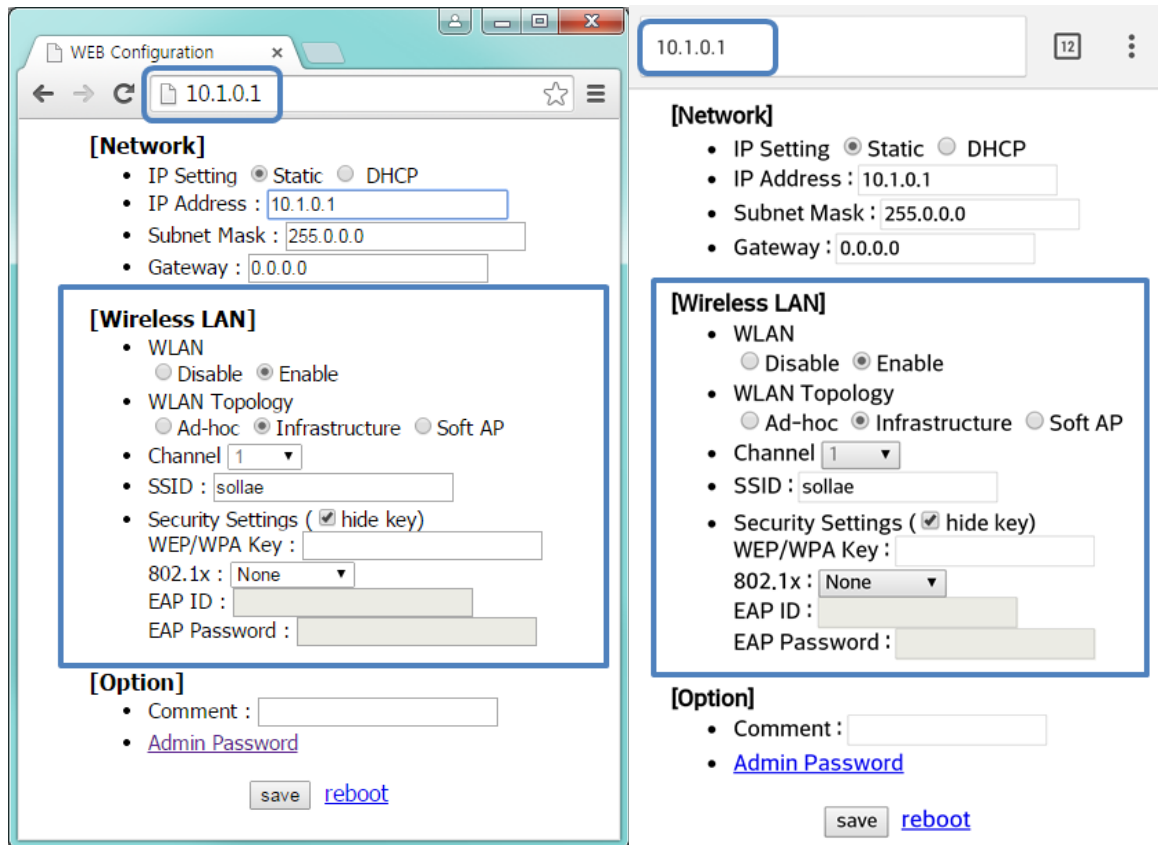

Figure 3-2 Connecting to Web configuration page (PC, Mobile)

- ⑥ Set additional environmental variables through ezManager
 After connecting to WLAN, you can set additional environmental variables (serial etc.) through ezManager.

3.1.2 Setting by wired LAN

ezManager and LAN adaptor are required on your PC.

- ① Supplying power
- ② LAN Connection
Connect CSC-H64 to your PC via a LAN cable
- ③ Run ezManager and set parameters

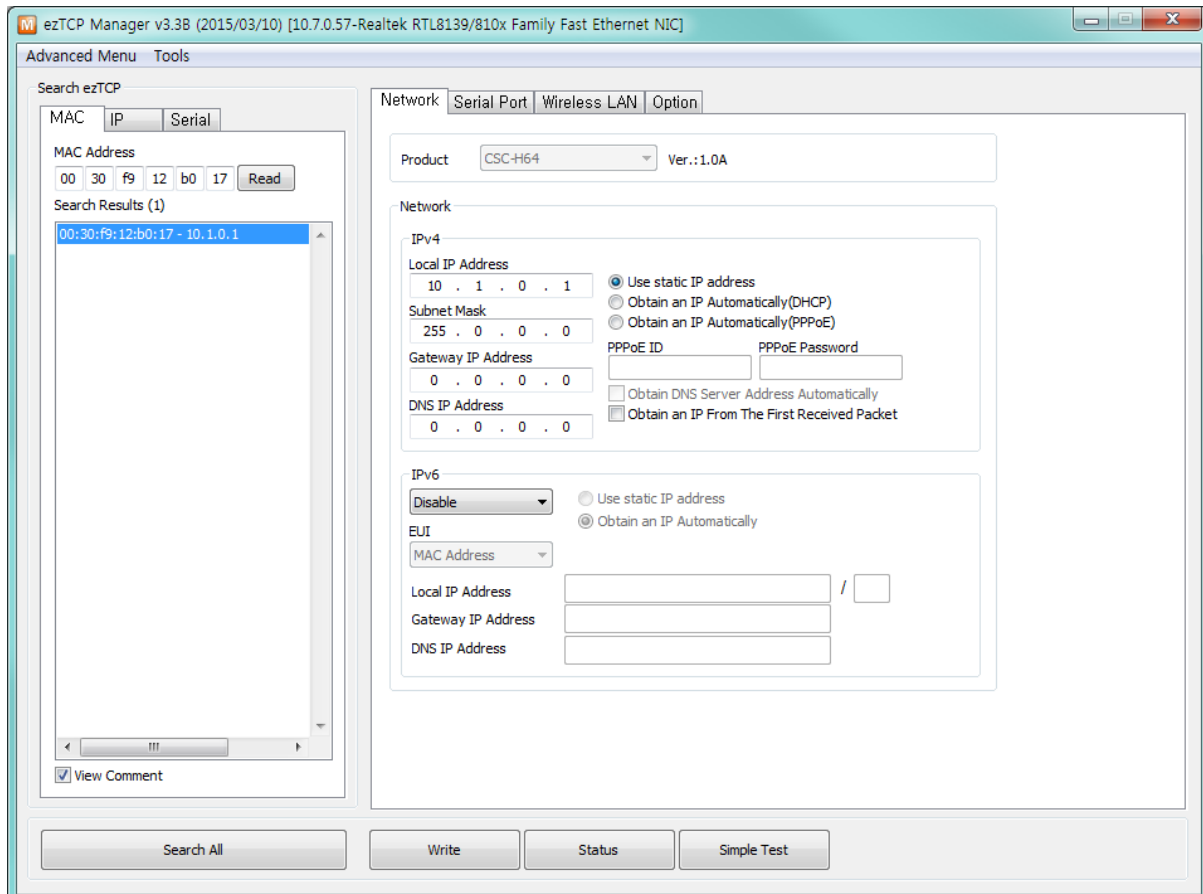

Figure 3-3 ezManager (LAN)

3.1.3 Setting by USB port

① Supplying power

② USB Connection

Connect CSC-H64 to your PC via a USB cable.

☞ *Device driver will be automatically installed when you connect CSC-H64 to your PC. When automatic installation fails, download and install the driver on ST Micro's web site.*

☞ *STM32 USB Virtual Com Port Driver Download page:*

<https://www.st.com/web/catalog/tools/FM147/CL1794/SC961/SS1533/PF25793>
8

③ Entering the Button setup mode

Press the function(Func.) button

④ Reading environmental parameters

Open a COM port which is connected with USB cable of [Serial] tab on ezManager and press [Read] button

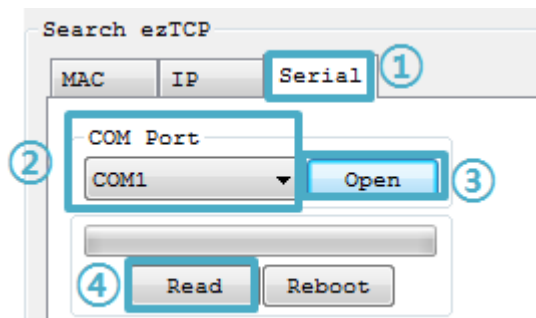

Figure 3-4 reading environmental parameters

⑤ Writing the environment parameters

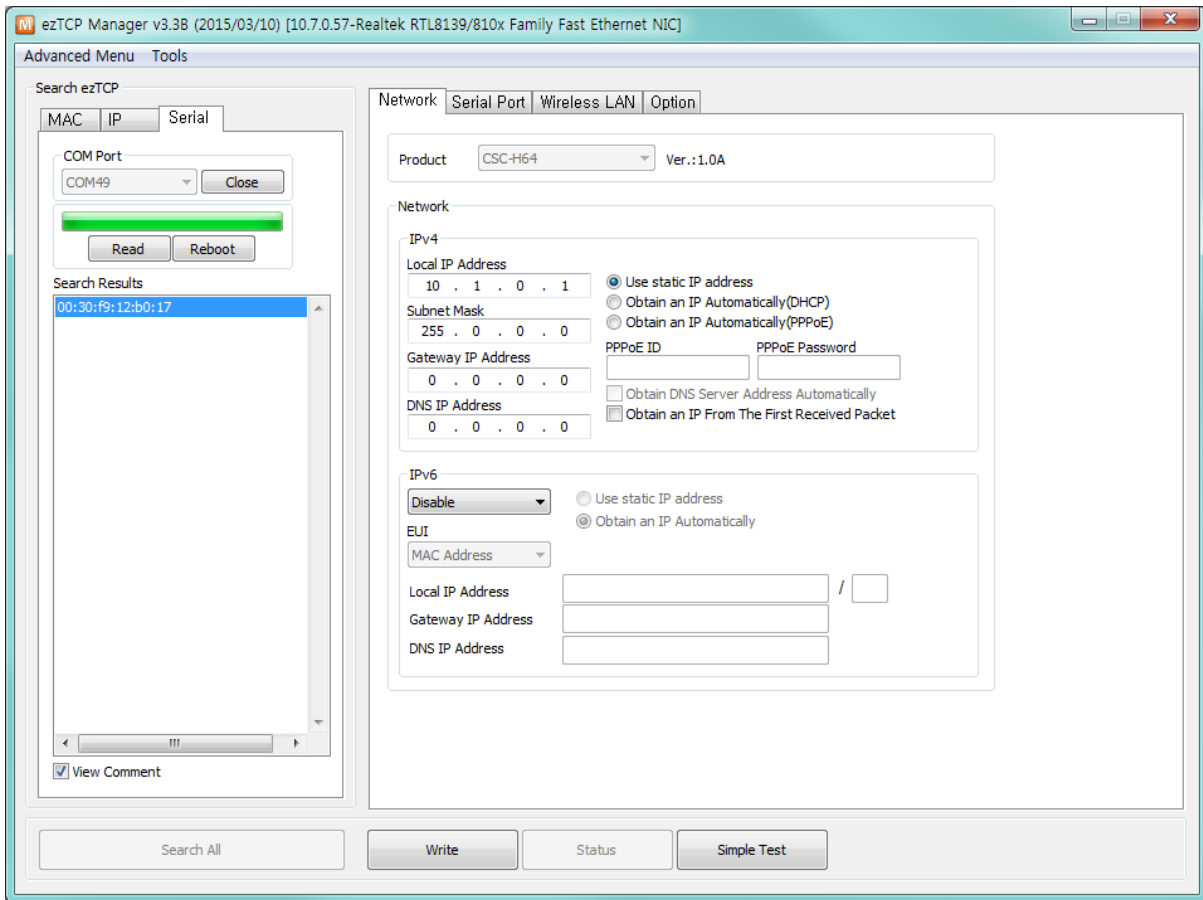

Figure 3-5 ezManager (USB)

3.2 AT command

In the AT command mode, you can change some parameters through the serial port.

- Requirements

Make sure the connection between your PC and CSC-H64 using RS232 cross cable. To use this mode, CSC-H64 has to be set to [AT command] mode on ezManager.

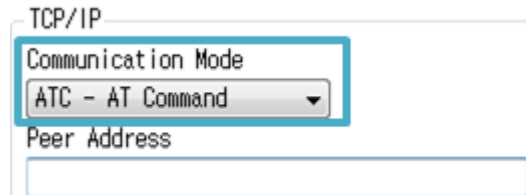

Figure 3-6 setting the communication mode to the AT command

- Procedures

- ① Supply the power
- ② Connect the serial cable
- ③ Set the communication mode to the AT command
- ④ Run a serial terminal program like Hyper Terminal
- ⑤ Set the values properly with the AT commands
- ⑥ Save the settings with AT+PWP command

- Available settings

Items	Available parameters
IP Address	Local IP Address, DHCP, Subnet Mask, Gateway IP Address and etc.
TCP connection	Local Port, Peer Address (IP Address or Host name), and etc.
WLAN	Topology, SSID, WEP, WPA-PSK, WPA2-PSK and etc.
Option	ESC code sending option, timeout and etc.

Table 3-1 available settings by AT command

4 Operation Mode

4.1 What is the Operation Mode?

Each of the three operation modes of CSC-H64 is defined for specific purpose as follows.

- Normal mode
This mode is for normal data communication and has 4 different connection modes. Configuring parameters is also available in this mode.
- Button Setup mode
This mode is for configuring environmental parameters through the USB port.
- ISP mode
You can set environmental parameters even though the security options like a password are activated.

4.2 How to entering each mode

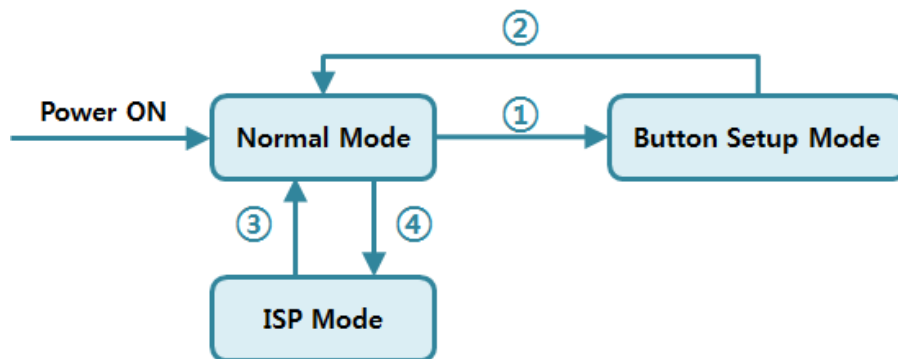

Figure 4-1 How to entering each mode

- ① Push the function button less than 1 second
- ② Reset
- ③ Reset
- ④ Push the function button over than 1 second

4.3 Comparison of each mode

Name	Serial port	Serial type
Normal	configured value	RS232
Button Setup	115,200bps	USB
ISP	115,200bps	USB

Table 4-1 comparison of each mode

4.4 Normal Mode

In normal mode, there are four connection types to communication with a remote host.

Mode	Description
TCP Server	Wait connection requests from TCP clients (Passive Connection)
TCP Client	Send connection requests to a TCP server (Active Connection)
AT Command	Control connections by AC commands (Active / Passive Connection)
UDP	Communicate in block units without connection

Table 4-2 comparison of communication modes 1

Name	Protocol	Connection	Modifying software of serial devices	Serial configuration	Topology
TCP Server	TCP	Passive	-	Unavailable	1:1
TCP Client		Active	-	Unavailable	1:1
AT Command		Either	Required	Available	1:1
UDP	UDP	-	-	Unavailable	N:M

Table 4-3 comparison of communication modes 2

4.5 Button Setup Mode

This mode is for setting environmental parameters through a USB port or WLAN. When you use USB port, you can set values at [Serial] tab of ezManager. And when you use WLAN, you can set the values through Web server.

4.6 ISP Mode

You can enter this mode by pressing the function button over 1 second.

CSC-H64 offers restriction methods for security like filtering passwords or MAC and IP addresses. In the ISP mode, you can revoke all of these. When you forget the password, enter the ISP mode to solve the problem.

- ☞ *When you change environment values in the ISP mode, the values may randomly change. After you change the environment, please quit the configuration and start the normal mode again to double check your new environment values.*

5 Communication Mode

5.1 TCP Server

In this mode, CSC-H64 runs as a TCP server. CSC-H64 listens to a TCP connection from a remote host. Once the host tries to connect to CSC-H64, it responds to that request. After the connection is established, CSC-H64 converts the raw data from the serial port to TCP/IP data and sends them to the network and vice versa.

5.1.1 Key parameters

- Event Byte

With setting event bytes, you can handle the serial data of the serial buffer before a TCP connection is established.

Value	Description
0	CSC-H64 does not send the data
Otherwise (512 or under)	CSC-H64 sends the data right after a connection is established. 512 or under bytes are strongly recommended.

Table 5-1 Event Byte

- Timeout

If there is no data transmission of data for the amount of time which is set to this parameter, CSC-H64 tries to terminate the established TCP connection.

- Notify IP Change

This function is for notifying information about a changed IP addresses to a management server. Not only can the TCP/UDP protocol be used, but Dynamic Domain Name Service (DDNS).

- Access restriction

You can block TCP connections from unauthorized hosts by using this option. Both IP and MAC addresses are available.

5.1.2 Examples

- A situation that [Event Byte] is set to 0.

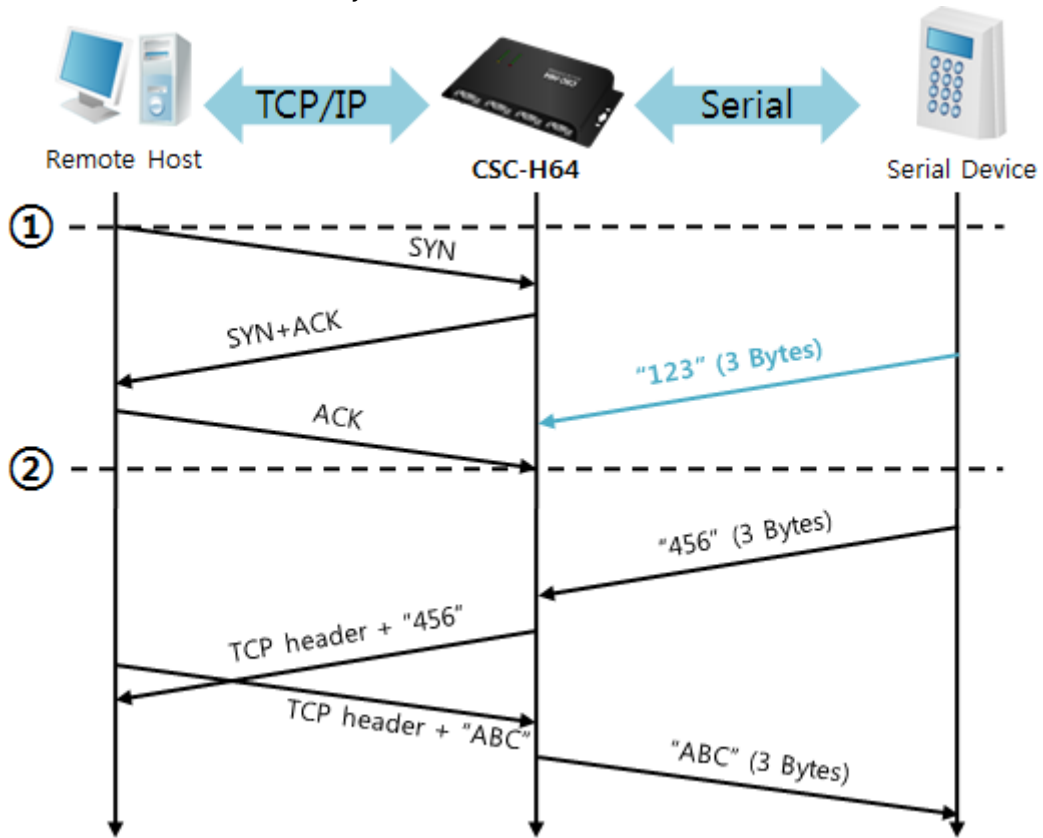

Figure 5-1 time chart

Points	States
~	CSC-H64 is listens to connection requests
①	Remote host sends a connection request (SYN) segment
~	Processes of the connection
②	The connection is established
~	Data communication is implemented on both side

Table 5-2 states of each point

Look at the blue arrow. The data "123" from the serial port has been sent before establishing a connection. In this case, the data is not sent because the [Event Byte] is set to 0.

- A situation that [Event Byte] is set to 1.

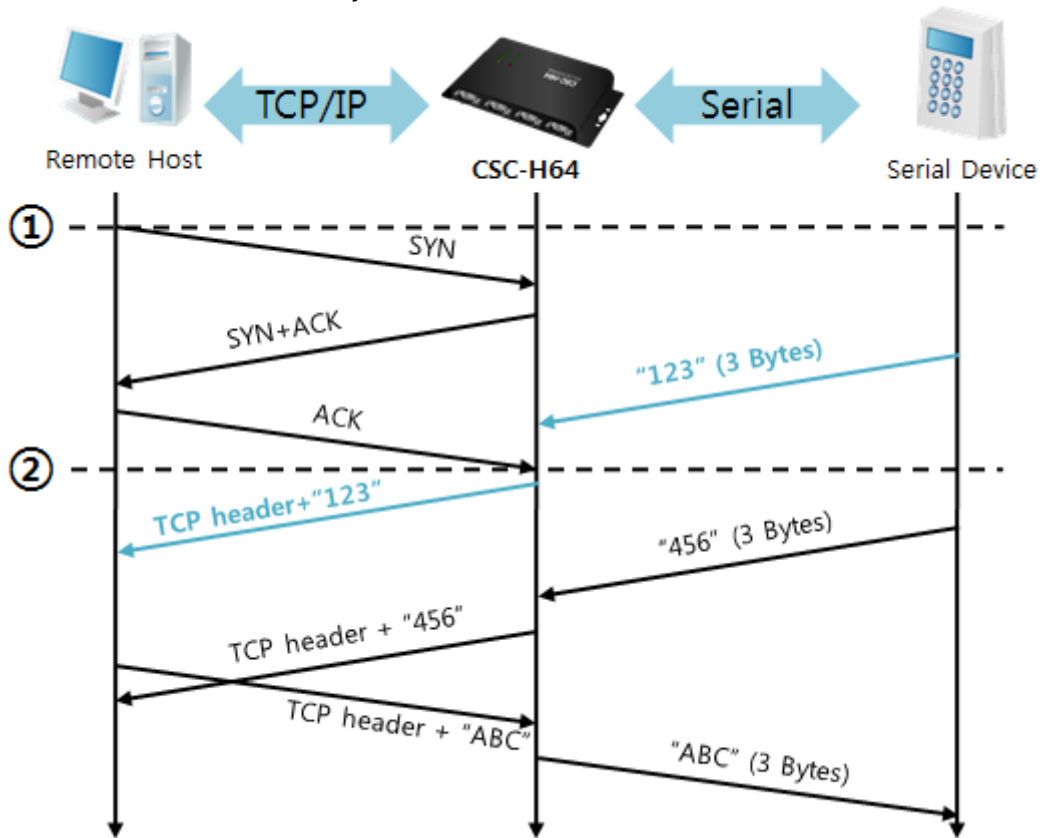

Figure 5-2 time chart

Points	States
~	CSC-H64 listens connection requests
①	Remote host sends a connection request (SYN) segment
~	Processes of the connection
②	The connection is established
~	Data communication is implemented on both sides

Table 5-3 states of each point

As you can see, the data "123" is sent right after establishing a connection because the value of [Event Byte] was set to 1. If the value is not 0, the result is the same as the above example.

- A situation that [Timeout] is set to 5.

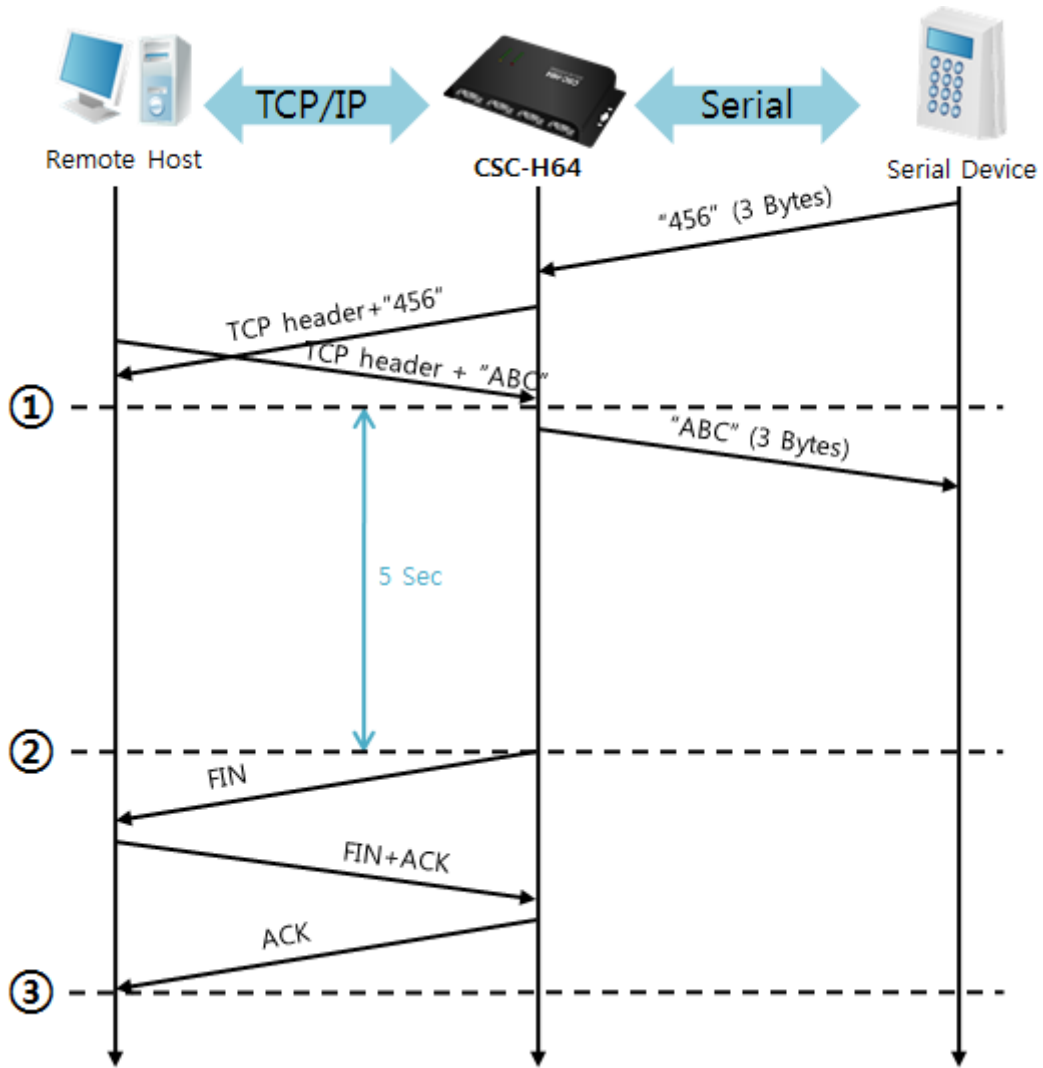

Figure 5-3 time chart

Points	States
~	Data communication on both sides
①	The last segment arrives at CSC-H64
~	No data communication for 5 seconds
②	CSC-H64 sends a disconnection request (FIN) to a remote host
~	Processes of the disconnection
③	The connection is terminated
~	CSC-H64 listens connection requests

Table 5-4 states of each point

5.2 TCP Client

In this mode, CSC-H64 sends request segments to a TCP server with information of [Server IP Address] and [Server Port]. Once a host is listening, the connection will be established. After then, CSC-H64 converts the raw data from the serial port to TCP/IP data, and sends them to the network and vice versa.

5.2.1 Key parameters

- Peer Address

This item is to put a host name or an IP address of TCP server.

- Peer Port

[Peer Port] is a port number of TCP server.

- Event Byte

This item can decide the point of time to send the connection request parameter.

Value	The point of time to send request segment
0	Right after CSC-H64 boots up
Otherwise (512 or under)	Right after the bytes set to [Event Byte] have been received from the serial port Setting to less than 512 bytes is strongly recommended.

Table 5-5 the operation of Event Byte 1

In addition, you can handle serial data before a TCP connection is established with this parameter.

Value	Description
0	CSC-H64 does not send data
Otherwise (512 or under)	CSC-H64 sends data right after a connection is established. Setting to less than 512 bytes is strongly recommended.

Table 5-6 the operation of Event Byte 2

- Timeout

If there is no data transmission for amount of the time the connection would be terminated.

- TCP Server

This check option is to enable the TCP Server / Client mode. In this mode, CSC-H64 can be operated as a TCP server or client without changing its settings.

- DNS IP Address

[DNS IP Address] is needed when user use a host name instead of an IP address.

5.2.2 Examples

- A situation that [Event Byte] is set to 0

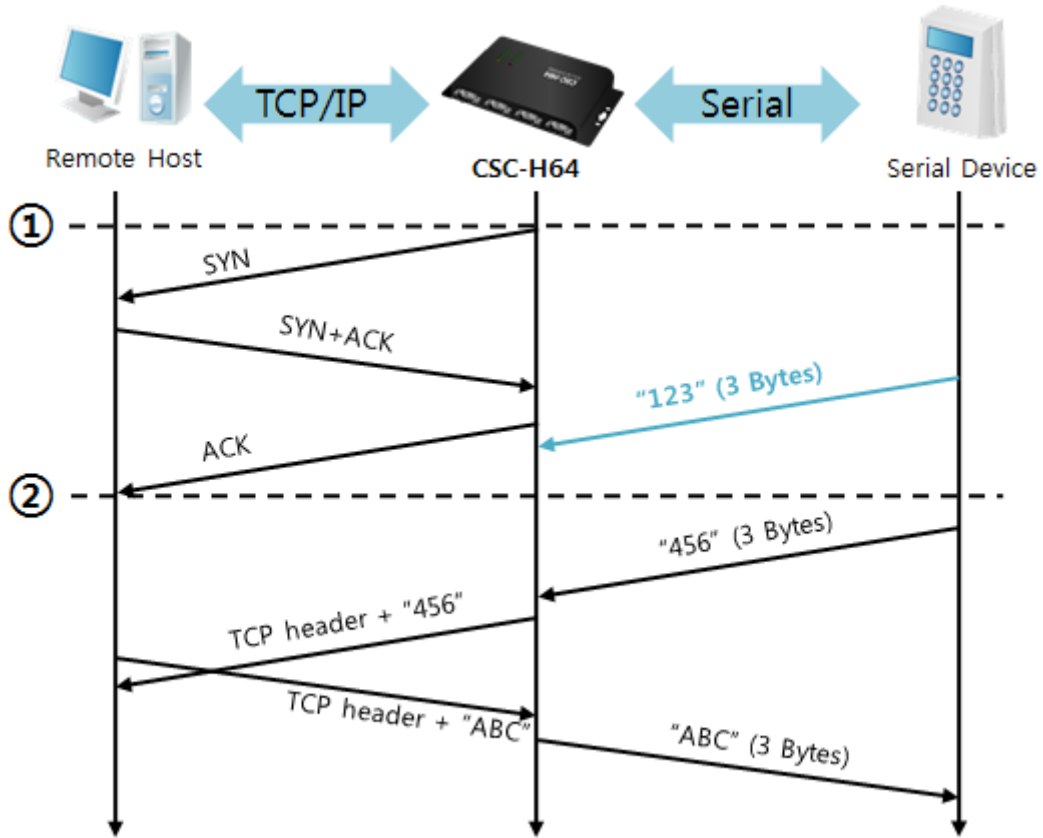

Figure 5-4 time chart

Time	States
~	Power is not supplied yet.
①	CSC-H64 sends a connection request segment right after it boots up.
~	processes of TCP connection
②	The connection is established.
~	data communication on both sides

Table 5-7 states of each point

Look at the blue arrow. The data "123" from the serial port is sent before establishing a connection. In this case, the data is not sent because of the [Event Byte] was set to 0.

- A situation that [Event Byte] is set to 5

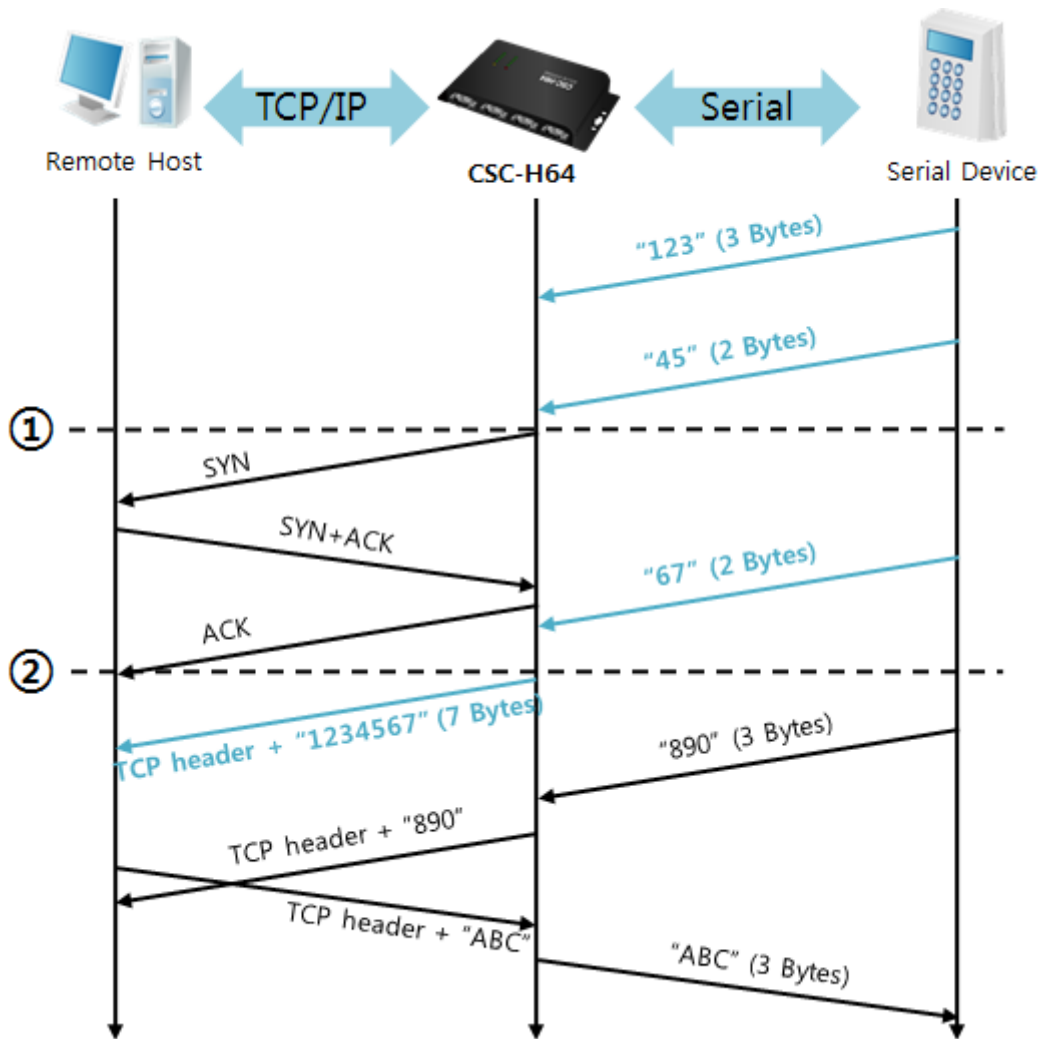

Figure 5-5 time chart

Time	States
~	CSC-H64 receives data from its serial port.
①	CSC-H64 sends a connection request segment right after receiving 5 bytes.
~	processes of the TCP connection
②	The connection is established.
~	The data "1234567" is transmitted to the remote host.

Table 5-8 states of each point

As you can see, CSC-H64 has sent a request segment right after the size of the serial data becomes 5 bytes. Even though those arrive before the connection, the data "123", "45" and "67" is transmitted to the remote host because the [Event Byte] was set to 5.

- Activation of [TCP Server] option

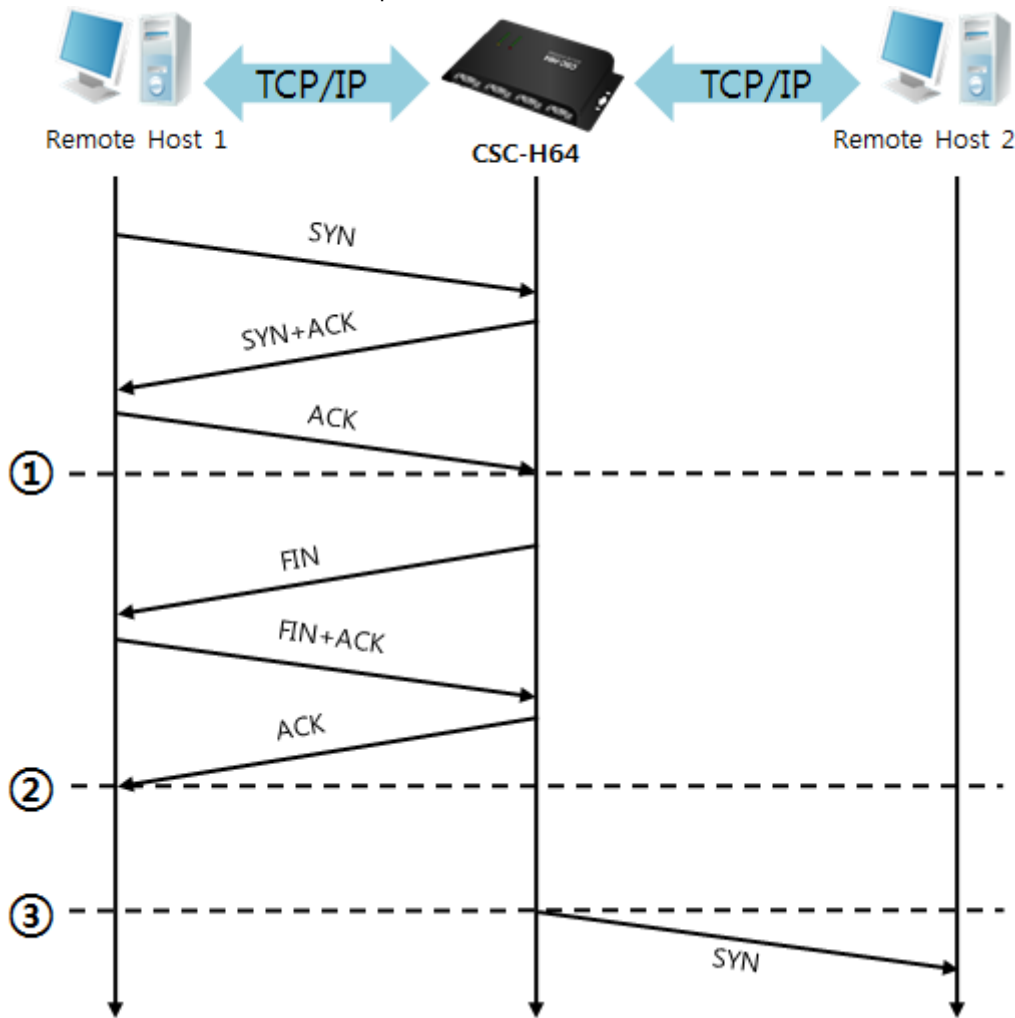

Figure 5-6 time chart

Time	States
~	CSC-H64 listens to connection requests
①	The connection is established
~	CSC-H64 is online and processes of the disconnection
②	The connection is terminated
~	Both sides are offline
③	Sends TCP connection request segment

Table 5-9 states of each point

The TCP Server / Client mode can be useful option due to [Event Byte] and [Timeout]. Note that only one TCP connection can be established at the same time, so users should consider setting [Timeout] properly.

5.3 AT Command

In AT command mode, you can control CSC-H64 with AT commands like a controlling a modem. Active and passive TCP connections are available while UDP is not. And you are allowed to configure some environmental parameters with extended commands.

5.3.1 Key parameters

The configuration should be implemented via the serial ports of CSC-H64.

Commands	Description	Examples
+PLIP	Local IP Address	at+plip=10.1.0.1<CR>
+PLP	Local Port	at+plp=1470<CR>
+PRIP	Peer IP Address	at+prip=10.1.0.2<CR>
+PRP	Peer Port	at+prp=1470<CR>
+PDC	DHCP	at+pdc=1<CR>
+PTO	Timeout	at+pto=10<CR>
+WCCT	WLAN Topology	at+wcct=1<CR>
+WSSID	SSID	at+wssid="sollae"<CR>
+PWP	Store setting	at+pwp<CR>

Table 5-10 some of extended AT commands for configuration

- Related items with an IP address and a Local Port
A Local port can be set as well as IP address related parameters like an IP address, Subnet Mask and Gateway IP address.
- Peer Address / Peer Port
An IP address and a local port of a remote host are can be set.
- Type of assigning an IP address: Manual, DHCP, PPPoE
Not only is manual setting available, but automatic assigning protocols (DHCP, PPPoE).
- WLAN parameters
WLAN Topology, SSID and antenna can be configured by the above commands.
- Others
Some of options including [Timeout] can be configured in this mode.

☞ ***Refer to the [AT Command mode] document on our website for details.***

5.3.2 Examples

- TCP Server – setting parameters and passive connection

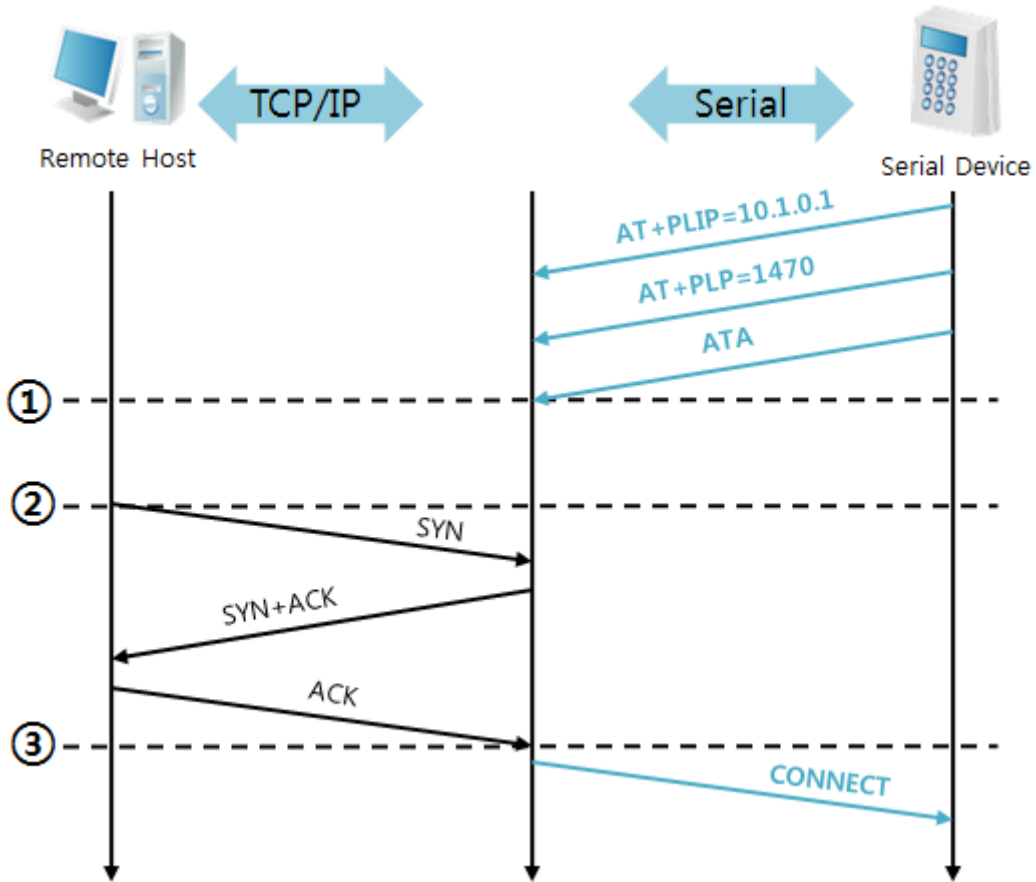

Figure 5-7 time chart

Time	States
~	configuring parameters with AT commands
①	ATA command has arrived.
~	CSC-H64 listens to TCP connection requests.
②	A remote host sends SYN segment to CSC-H64.
~	processes of TCP connection
③	TCP connection is established.
~	CSC-H64 sends "CONNECT" message to the serial port.

Table 5-11 states of each point

☞ *Some of the response messages from the serial port of CSC-H64 are omitted on above figure.*

- TCP Client – setting parameters and active connection

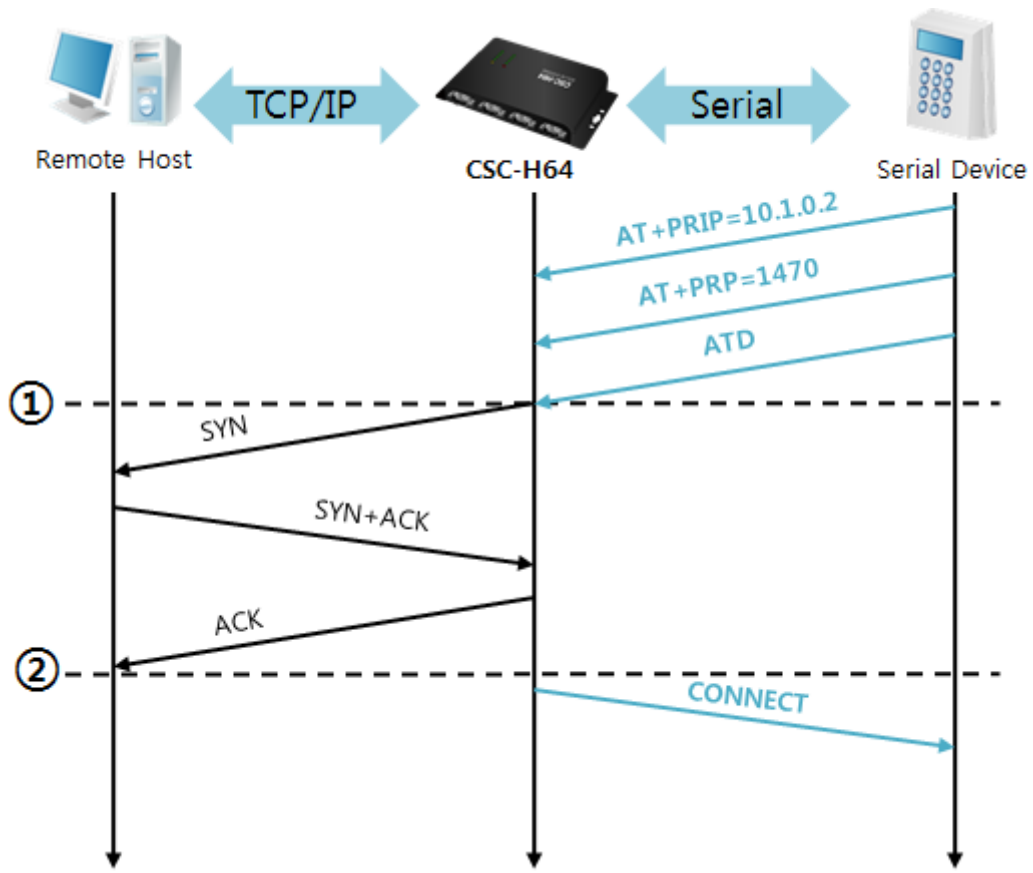

Figure 5-8 time chart

Time	States
~	configuring parameters with AT commands
①	CSC-H64 sends TCP connection request with the ATD command.
~	processes of TCP connection
②	TCP connection is established.
~	CSC-H64 sends "CONNECT" message to the serial port.

Table 5-12 states of each point

- Termination of online status – entering the AT command mode

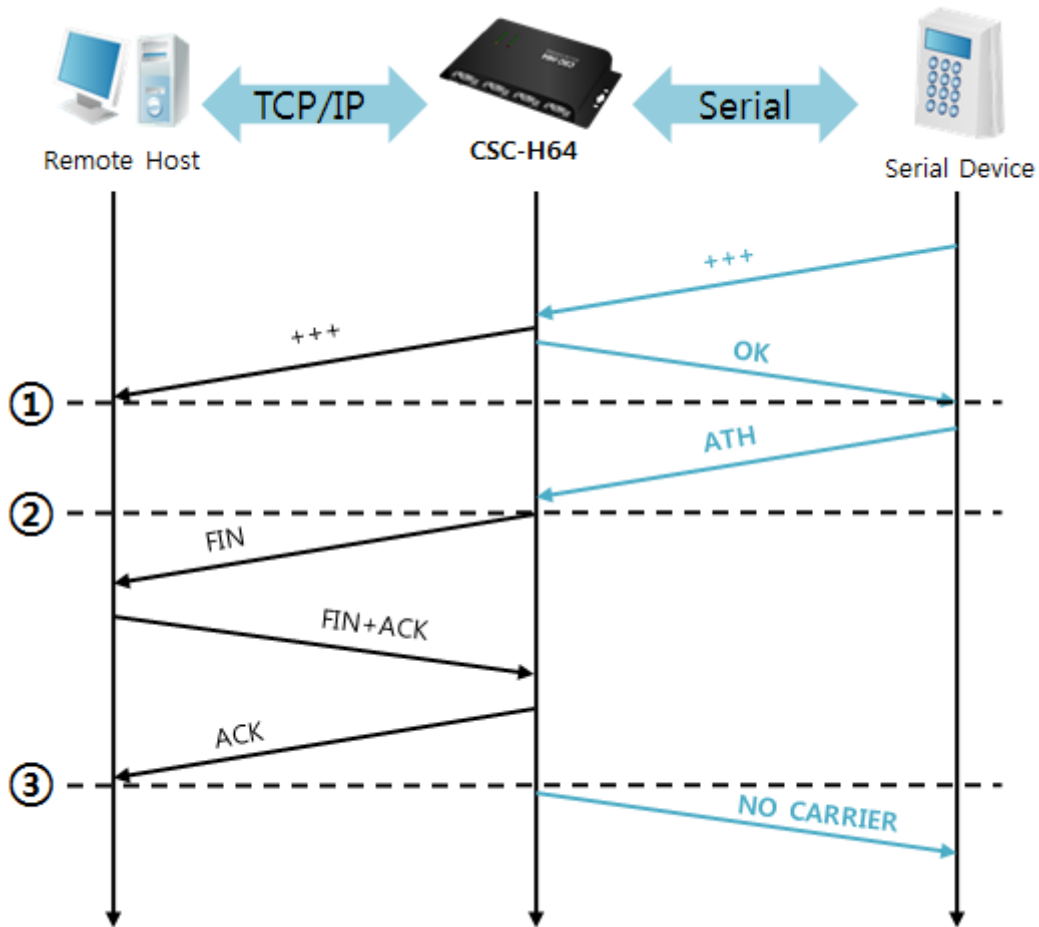

Figure 5-9 time chart

Time	States
~	TCP connection is on-line.
①	The mode is changed to "command mode" after receiving "+++".
~	command mode (TCP connection is off-line)
②	CSC-H64 sends FIN segment right after the "ATH" arrives.
~	processes of TCP disconnection
③	TCP connection is terminated
~	CSC-H64 sends "NO CARRIER" with disconnection.

Table 5-13 states of each point

CSC-H64 changes the mode to AT command, when receiving "+++". In this state, the communication with remote host is unavailable because CSC-H64 processes only AT commands. Whenever you want to go back to on-line state, just give "ATO" command.

5.4 UDP

UDP has no connection processes. In this mode, data is sent in block units. Therefore, data that comes through CSC-H64's serial ports is collected in block units to send it elsewhere.

5.4.1 Key parameters

- Block Size

[Block Size] is to set the time to gather data in one block. Its unit is byte. If the data in configured size of the [Block Size] comes into the serial port, CSC-H64 will send them as one block to the network. The maximum value could be 1460 bytes.

- Dynamic update of Peer host

If you set the value of [Peer Address] and [Peer Port] to 0, [dynamic update of peer host] function is activated. By using this function, CSC-H64 can communicate with multiple hosts without additional setting.

5.4.2 Examples

- Block Size: 5 bytes

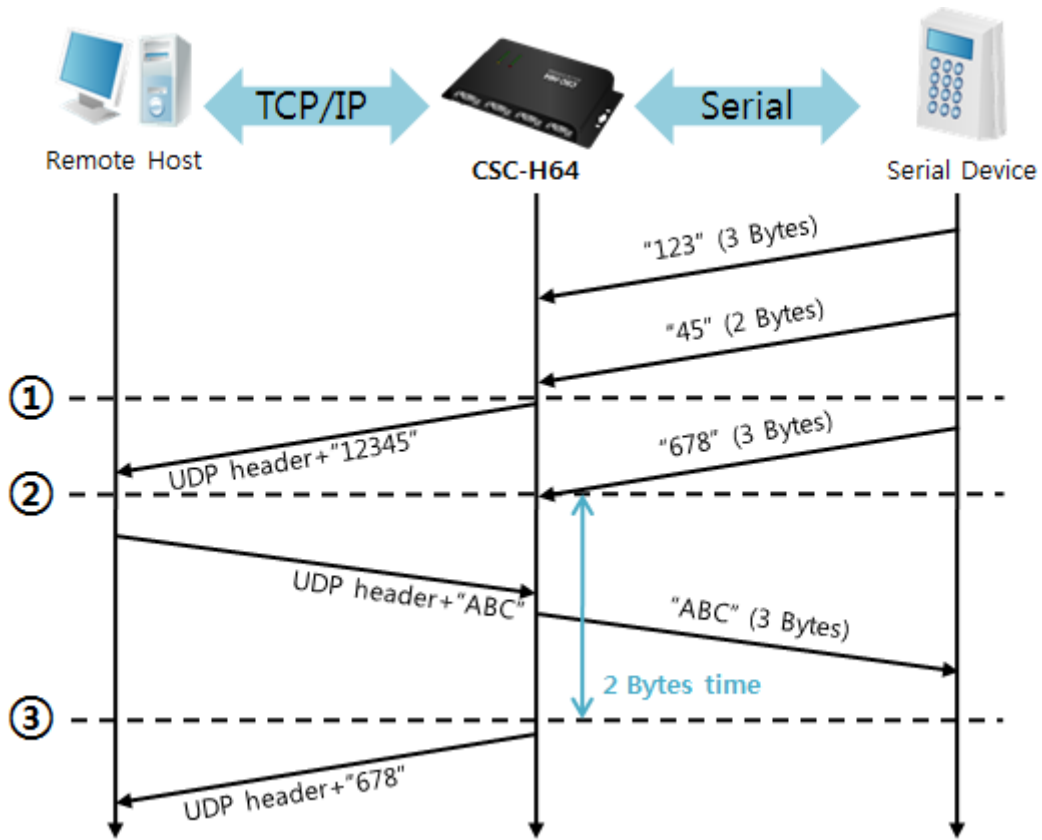

Figure 5-10 time chart

Time	States
~	CSC-H64 receives data from the serial port
①	CSC-H64 sends 5 bytes as one block based on the [Block Size]
~	A serial device sends data "678" to CSC-H64
②	Data "678" arrives
~	CSC-H64 sends data from the remote host to the serial device
③	2bytes time passes
~	CSC-H64 sends data "678" as one block based on the [Data Frame]

Table 5-14 states of each point

☞ **CSC-H64's Data Frame interval is configured 2byte data interval. Before sending data from the serial port to LAN, CSC-H64 gathers data in the buffer. If there is no data during the time configured in the 2byte data interval, it will send data to the network.**

- Dynamic Update of a Peer host

This is a function that CSC-H64 automatically sets its peer host with information of the last packet received from network. The source address of the packet is set to the peer host.

Parameters	Values
Peer Address	0 (None)
Peer Port	0

Table 5-15 setting for [dynamic update of a peer host] function

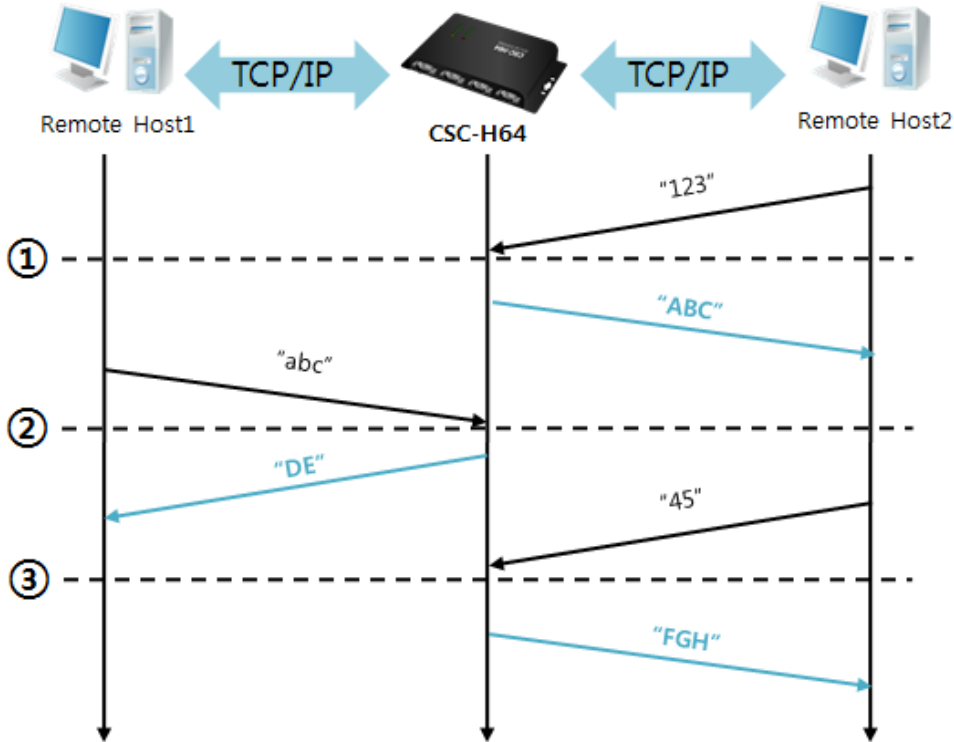

Figure 5-11 time chart

Time	States
~	Sending any UDP data to the network is impossible.
①	UDP data arrives from Remote Host 2.
~	Send UDP data to Remote Host 2.
②	UDP data arrives from Remote Host 1.
~	Send UDP data to Remote Host 1.
③	UDP data arrives from Remote Host 2.
~	Send UDP data to Remote Host 2.

Table 5-16 states of each point

☞ **The data "ABC", "DE", "FGH" in the above figure is from the serial port of CSC-H64.**

6 System Management

6.1 Upgrading Firmware

6.1.1 Firmware

Firmware is a type of software to operate CSC-H64. If there are in need of adding functions or fix bugs, the firmware can be modified and released. For this reason, we recommend using the latest version of the firmware.

6.1.2 Processes

- Downloading the latest firmware
Download the latest firmware file uploaded at our website.
- Run ezManager program for sending the Firmware file
Run the program on ezManager.

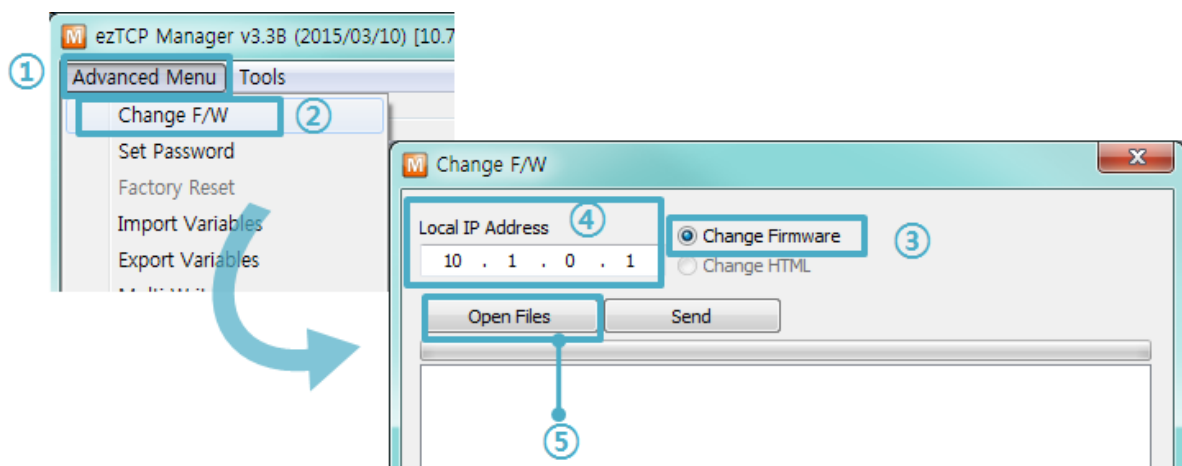

Figure 6-1 sending firmware file

- ① Check the [Advanced Menu]
- ② Click the [Change F/W] button to run TFTP client
- ③ Select the [Change Firmware] radio button
- ④ Input the IP address of CSC-H64 to the [Local IP Address] text box
- ⑤ Press the [Open Files] button and choose the firmware file

- Checking firmware file and Sending

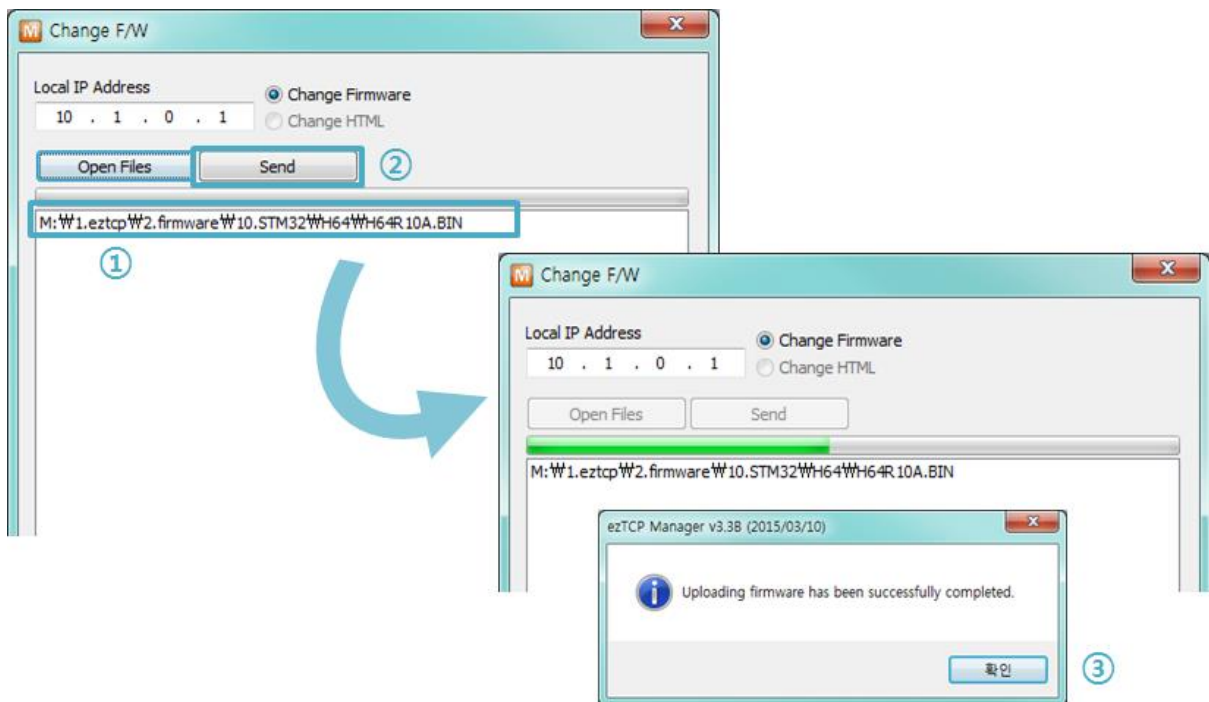

Figure 6-2 sending firmware file

- ① Check if the name and path of the firmware file are correct
- ② Click the [Send] button
- ③ Confirm the completed message

☞ *When a password is required, enter your password. Starting with firmware version 2.0A, you can upgrade the firmware by entering "sollae" without setting a password.*

6.2 Status Monitoring

6.2.1 Using TELNET

Once the [TELNET] option is activated, users can remotely log in to CSC-H64. If a password is set, users should input the password.

☞ **Starting with firmware version 2.0A, you can login by entering "sollae" without setting a password.**

After then, messages from CSC-H64 appear like the figure below.

```
CSC-H64 Management Console v2.0A Sollae Systems
password: *****
lsh>
```

Figure 6-3 log in to CSC-H64 on TELNET

The following commands let users check each state.

Command	Option	Description	Usage
st	net	IPv4 Network Status	lsh>st net
	net6	IPv6 Network Status	lsh>st net6
	sio	Serial Port Status	lsh>st sio
	uptime	System Uptime	lsh>st uptime
sc	[OP1][OP2]	Session Control	lsh>sc com1 close
sd	[OP1][OP2]	Serial Data Capture	lsh>sd 1 100
		Stop Serial Data Capturing	lsh>sd 1 0
exit		Telnet Session Exit	lsh>exit

Table 6-1 commands for checking states

- st net

"st net" command displays the current IPv4 network states of all sessions.

```
lsh>st net
proto name      local address      peer address      sendq  state
-----
TCP   tty           10.1.0.1( 23)     10.6.0.50(52676) 219  ESTABLISHED
TCP   com4           0.0.0.0(14703)    0.0.0.0( 0)      0  LISTEN
TCP   com3           0.0.0.0(14702)    0.0.0.0( 0)      0  LISTEN
TCP   com2           0.0.0.0(14701)    0.0.0.0( 0)      0  LISTEN
TCP   com1           0.0.0.0(14700)    0.0.0.0( 0)      0  LISTEN
lsh>
```

Figure 6-4 "st net" command

- st net6

"st net6" command displays the current IPv6 network states of all sessions.

```
lsh>st net6
```

proto	name	local/peer address	sendq	state
TCP6	com1	fe80::230:f9ff:fe12:b018(14700) fe80::ad74:b072:428f:4d3(52736)	0	ESTABLISHED

Figure 6-5 "st net6" command

- st sio

"st sio" command displays the number of bytes for the serial port.

```
lsh>st sio
```

port	fmax	rbmax	rxbuf	txbuf	rx_count	tx_count
com1	0	0	0	0	0	0
com2	0	0	0	0	0	0
com3	0	0	0	0	0	0
com4	0	0	0	0	0	0

Figure 6-6 "st sio" command

- st uptime

"st uptime" command shows amount of time since CSC-H64 boots up.

```
lsh>st uptime
00:02:42.24 up 0 days
```

Figure 6-7 "st uptime" command

- sc

"sc" command is used when users close a session. [OP1] means the name of session, and [OP2] should be "close".

```
lsh>sc com1 close
com1: closed
```

Figure 6-8 "sc" command

☞ *In case of the "sc" command you should use only small letters.*

- sd

"sd" command is for capturing serial data. [OP1] means name of the session, [OP2] means period, which has a 10ms unit, for the capture.

```
lsh>sd 1 100
com1 dump start
com1 dump buffering time : 1000ms
lsh>tx1 => 30 31 32 33 34 35 36 37          | 01234567
tx1 => 30 31 32 33 34 35 36 37          | 01234567
```

Figure 6-9 "sd" command

If you input 0 to the [OP2], it stops the capture.

```
lsh>sd 1 0
com1 dump stop
```

Figure 6-10 stop capture

- exit

"exit" command is used when users close Telnet session.

6.2.2 Using ezManager

Status of CSC-H64 can be monitored by [Status] button on ezManager. By using the [Refresh Every 1 Second] option in the status window, the status is automatically updated in every second.

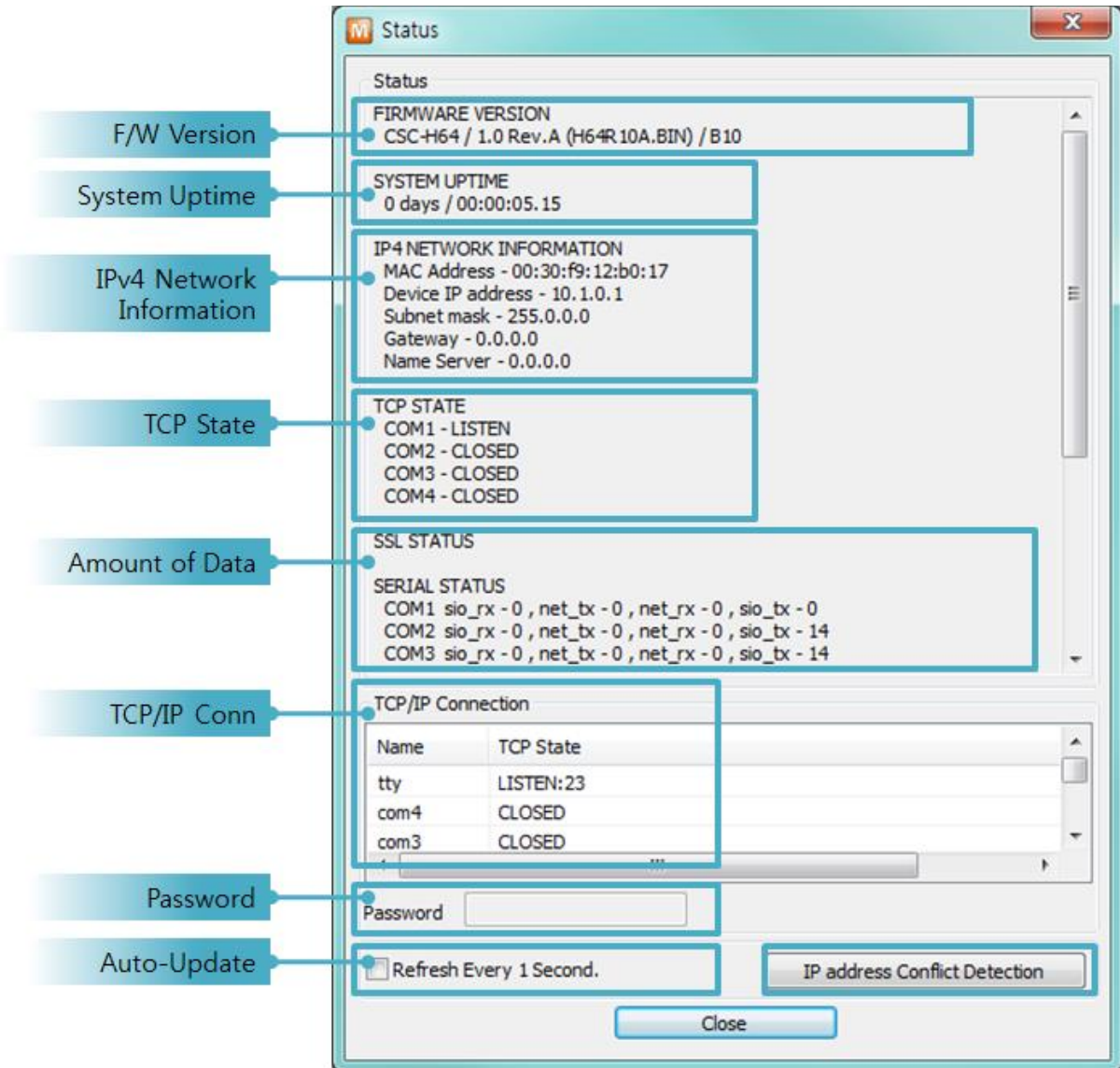

Figure 6-11 status window of ezManager

- **FIRMWARE VERSION**
The name of model name and the version of firmware are displayed here.
- **SYSTEM UPTIME**
Amount of time is displayed since CSC-H64 boots up.
- **IP4 NETWORK INFORMATION**
All information about related items with IPv4 Address is shown here. It works even if the IP address is assigned from DHCP or PPPoE.

- IP6 NETWORK INFORMATION

All information about related items with IPv6 Address is shown here. It works even if the IP address is assigned from DHCP or PPPoE.

- TCP STATE

TCP status of each port is shown this section.

Message	Description
LISTEN	listening TCP connection
CLOSE	TCP connection is closed
SYN_SENT	Send "SYN" segment to make TCP connection
ESTABLISHED	When TCP connection is established
N/A	In UDP mode

Table 6-2 TCP state

- SSL STATUS

SSL certificate status of CSC-H64 is displayed.

- SERIAL STATUS

Amount of data in every buffer is displayed. The unit is byte.

Buffer	Description
sio_rx	The number of data which is received from the COM port
net_tx	The number of data which is sent to the remote host
net_rx	The number of data which is received from the remote host
sio_tx	The number of data which is sent to the COM port

Table 6-3 serial status

- ARP/ND CACHE TABLE

This part shows ARP table on CSC-H64. When TCP connection is established or UDP data communication is performed, the information of IP and MAC address is automatically stored in the ARP table. This information is held for 1 minute. When 50 seconds is passed, CSC-H64 starts broadcasting the ARP packet again. If there is no response until the time is 0, the information is removed. If there is response, the time is updated to 60 seconds again.

In IPv6 case, it shows ND cache list. User can check by the ND cache messages. The messages are as follows.

Status	Description
INCOMPLETE	This means the device is standing by after it sends the request message, Neighbor Solicitation, to MAC and link local address of an opponent in the initial communication.
REACHABLE	This means the device has information about the opponent after it sends Neighbor Solicitation, and receives Neighbor Advertisement.
STALE	The device will change into STALE state later after some time later reaching REACHABLE.
DELAY	The device will change into DELAY state if there is no response to Neighbor Solicitation. In this case, CSC-H64 will not be able to communicate with the device.
PROBE	CSC-H64 will resend the request message to the device in DELAY state. CSC-H64 will keep sending Neighbor Solicitation until it replies.

Table 6-4 5 states displayed on ND Cache table

- TCP TIMER

Time information about TCP timer is displayed. (Keep Alive, Disconnect, Retransmission, Delayed ACK, Nagle)

- TCP/IP Connection

In this section, the same information with TCP STATE is displayed with IP address and port number. A difference is that users can terminate TCP connection. When right click on a session, a small pop-up window is created.

- Password

This text box is activated when CSC-H64 has a password. If users want to close TCP connection with right click of mouse on the session, this password has to be correctly filled.

- Refresh Every 1 Second.
If this option is checked, ezManager send query in every second.
- IP address Conflict Detection
By clicking this button, you can find devices which have the same IP address to yours on the network.

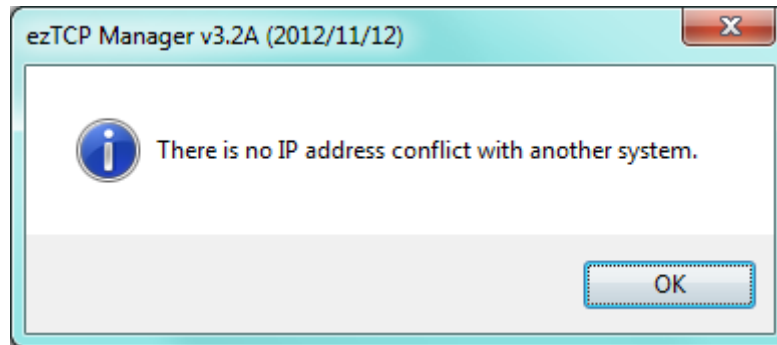

Figure 6-12 in case of no IP address conflict detection

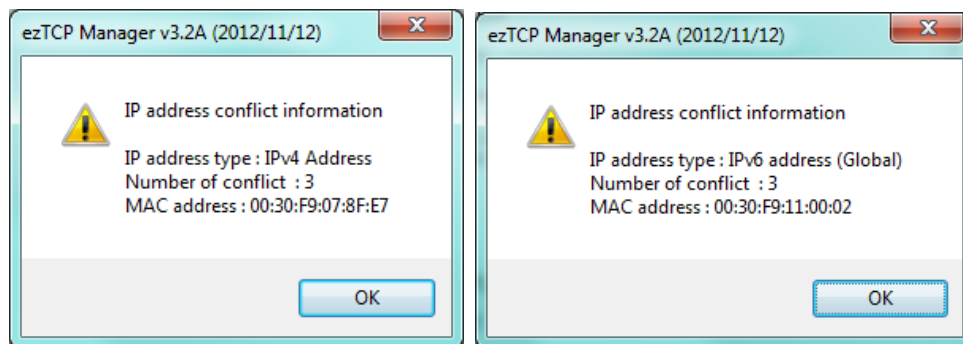

Figure 6-13 IP address conflict detection

7 Security Functions

7.1 SSL

7.1.1 What is the SSL(Secure Socket Layer)?

SSL is cryptographic protocol that provides secure communication on the Internet. The SSL works over TCP.

7.1.2 How to set the SSL

To works for SSL, you have to set the SSL-related parameters as the following steps. Set the [SSL] check box in the ezManager.

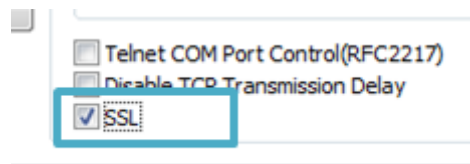

Figure 7-1 setting of option

- In case of T2S-TCP server mode, user make a certification and write it at CSC-H64. Please check the followings.

- ① Click the [Advanced Menu] → [Certificate] of the ezManager.

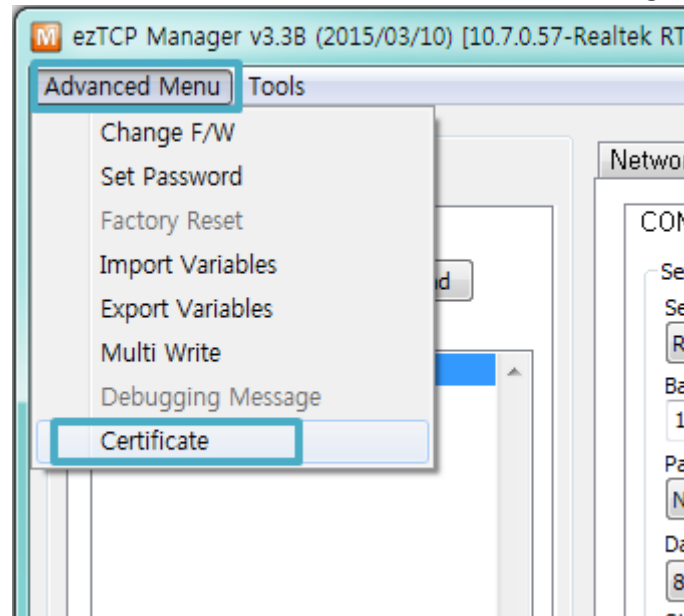

Figure 7-2 create the certification

- ② Choice the [Write self-signed certificate]

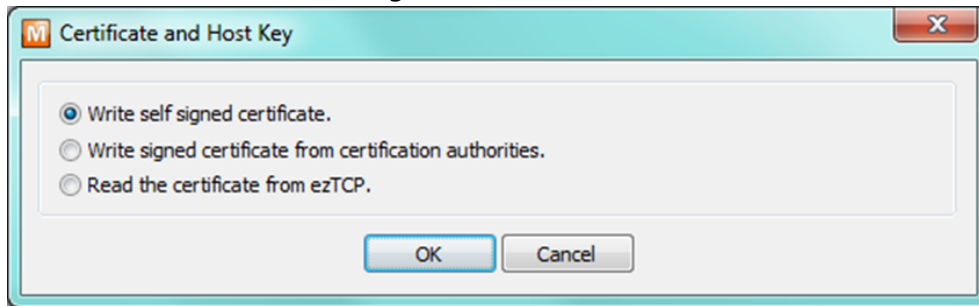

Figure 7-3 create the RSA Key

- ③ Input the key length and information in [Self signed certificate]

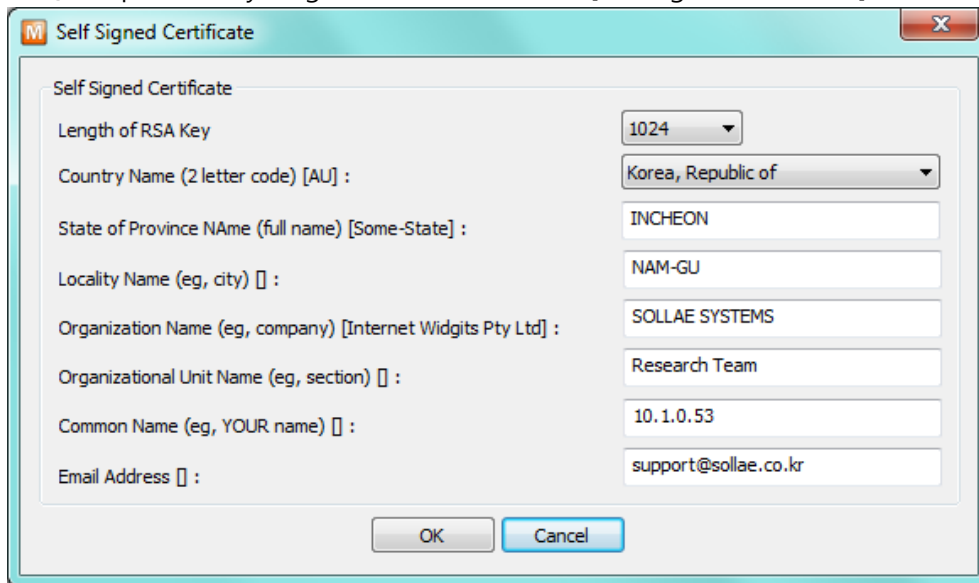

Figure 7-4 input the information

- ④ Check a success message.

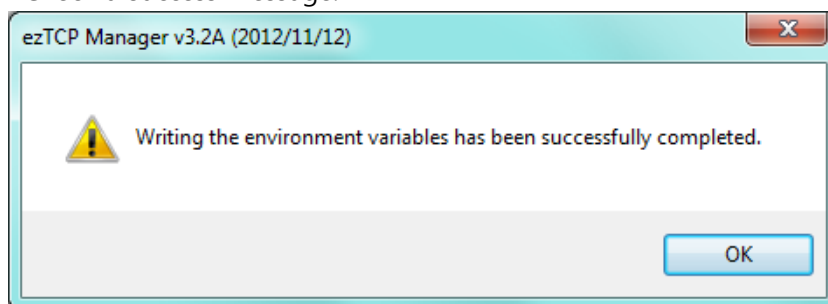

Figure 7-5 check of success message

7.1.3 Restriction

This function cannot be used simultaneously with IPv6, and the serial communication speed is limited to 115,200 bps. Since the certificate also has its own IP information, if the IP address is changed, a new certificate must be created.

7.2 Security

7.2.1 Access Restriction (ezTCP Firewall)

On the [Option] tab of ezManager, you can set access restriction function with MAC and IP address.

- Allowed MAC Address

If this option is enabled, the device which has the allowed MAC address is only permitted to access.

- Allowed IP Address

This is for qualifying hosts with IP address or range of IP addresses. The range is defined by multiplying [IP address] and [Network Mask] in bit unit.

- Examples for IPv4

IP Address	Network Mask	Allowed IP Address Range
10.1.0.1	255.0.0.0	10.1.0.1 ~ 10.255.255.254
10.1.0.1	255.255.255.0	10.1.0.1 ~ 10.1.0.254
192.168.1.4	255.255.255.255	192.168.1.4

Table 7-1 examples of defining allowed IPv4 range

- Apply to ezManager

[Apply to ezManager] is for applying above two restrictions to ezManager functions like [Search], [Read], [Write] and etc.

- Examples for IPv6

IPv6 Address	Prefix	Allowed IP Address Range
2001:DB8::100	64	2001:DB8::1 ~ 2001:DB8::FFFF:FFFF:FFFF:FFFF
2001:DB8::100	128	2001:DB8::100

Table 7-2 examples of defining allowed IPv6 range

7.2.2 Setting Password

A password can be used for protecting CSC-H64 from TELNET login or changing environmental parameters by unqualified hosts. The maximum length is 8 bytes of Alphabet or number.

☞ When you want to revoke all of these restrictions, operate CSC-H64 as ISP mode. In the mode, all restrictions are removable and communication with ezManager is revoked.

7.2.3 Using WEP

- AP settings

Set parameters such as authentication mode(open / shared) and key length(64 / 128) on your AP. If you do not know how to set AP's parameters, refer to the manual or ask the manufacturer.

- CSC-H64 settings

Input WEP Key, which is set on the AP, in [Shared Key] text box of [Security Settings] section on [WLAN] tab of ezManager.

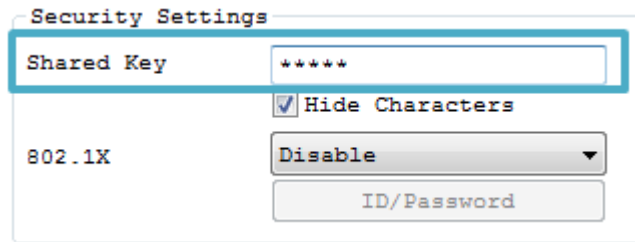

Figure 7-6 shared key settings

Type		Digit	Example
WEP64(64bits)	ASCII	5	abcde
	Hexadecimal	10	6162636465
WEP128(128bits)	ASCII	13	0123456789abc
	Hexadecimal	26	30313233343536373839616263

Table 7-3 WEP key settings

7.2.4 Using WPA-PSK

- AP settings

Set the WPA-PSK or WPA2-PSK and related parameters on your AP. If you do not know how to set AP's parameters, refer to the manual or ask the manufacturer.

- CSC-H64 settings

Input WPA-PSK Key, which is set on the AP, in [Shared Key] text box of [Security Settings] section on [WLAN] tab of ezManager. (See the Figure 7-6 shared key settings)

The length of Key for WPA-PSK should be 8 ~ 63 characters.

7.2.5 Using WPA-Enterprise

- Configuration of the Access Point

Set the WPA-Enterprise for authentication and radius server to communicate. If you do not know how to set AP's parameters, refer to the manual or ask the manufacturer.

☞ **CSC-H64 supports EAP-TLS / TTLS and PEAP.**

- Configuration of the product

Select one of authentication protocols on 802.1X item in the Security Settings.

Protocol	required configurations
EAP-TLS	ID of radius server account, client certificate
EAP-TTLS	ID and passphrase of radius server account
PEAP	ID and passphrase of radius server account

Table 7-4 802.1X item

- How to use EAP-TLS

In the case of EAP-TLS, a certificate is needed to save by ezManager.

The procedures are as follows:

- ① Configure the ID of radius server account
- ② Click the [Advanced Menu] → [Certificate] of the ezManager

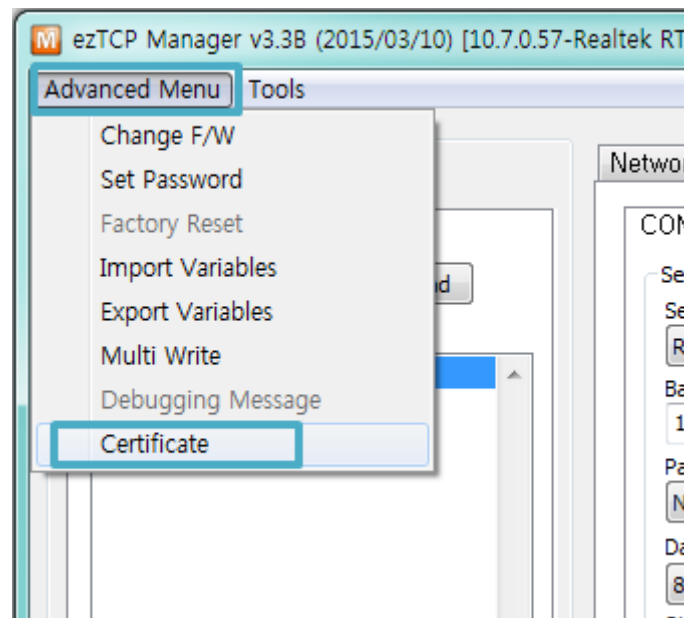

Figure 7-7 Certificate button

- ③ Save the client certificate made by radius server

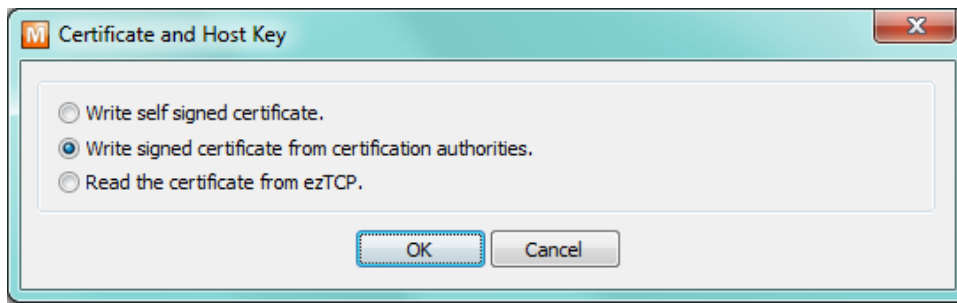

Figure 7-8 saving client certification

- ④ Input password for the certificate
- ⑤ Check the information of the certificate

7.2.6 Advanced Settings

You can configure advanced settings for WLAN with this button. We recommend using the default values if you do not have any problem with it.

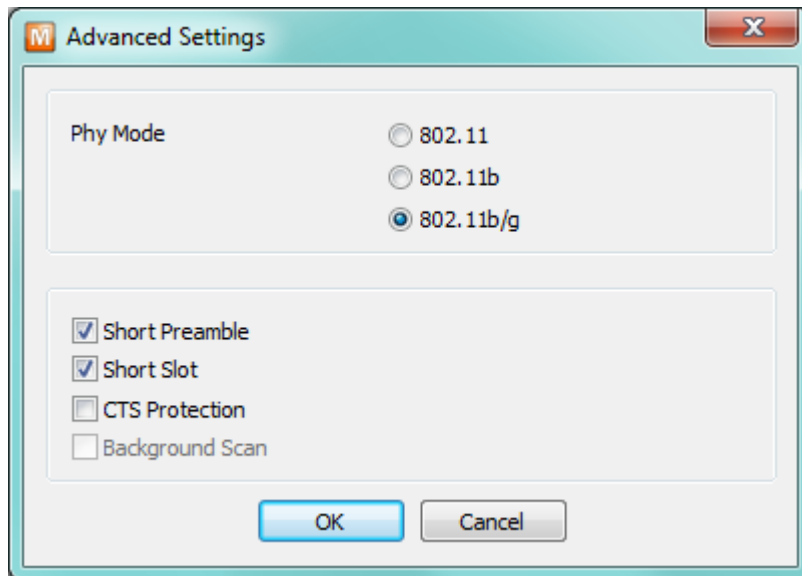

Figure 7-9 Advanced Settings

- PHY Mode

You have three options for PHY mode and those are [802.11], [802.11b] and [802.11b/g] mode.
- Short Preamble

Under good condition of WLAN environment, you can expect a slight improvement by enabling this option. Otherwise, you had better to disable this option.
- Short Slot

Using this option, you can expect some improvement in WLAN performances. If you are in bad condition of WLAN environment, you had better to disable this option.
- CTS Protection

Using this option, you can expect some improvement in WLAN performances under WLAN environment that both 802.11b and 11g devices are.

8 Additional Functions

8.1 Option Tab Functions

8.1.1 Notify IPv4 Change

CSC-H64 can be a TCP server even though it is assigned an IP address automatically. Using [Notify IP Change] function, CSC-H64 sends its IP address with the host name to the designated server. There are 3 types- DDNS, TCP and UDP for this service.

- Dynamic Domain Name Service (DDNS)

CSC-H64 supports DDNS service offered by DynDNS. Therefore, you have to make an account and create host names on the website of DynDNS before you use.

☞ *All about service usage of an account could be changed according to the policy of DynDNS.*

☞ *DynDNS website: <https://dyn.com/dns/>*

Figure 8-1 setting DDNS

- ① Select the [DDNS(dyndns.org)]
- ② 40,320 is a fixed value
- ③ Input the ID of DDNS account
- ④ Input the password of the account
- ⑤ Input a host name which you create on your account

- TCP/UDP

In case you have your own server and want to manage the information about changed IP addresses, you are allowed to use TCP/UDP by using this option. The [Data Type] can be ASCII or hexadecimal, and the [Interval] is available on configuration.

☞ *Refer to the [IP Change Notification] document on our website for details.*

8.1.2 Sending MAC Address

[Sending MAC Address] is a function that CSC-H64 sends its MAC address to the remote host right after the connection is established. By using this function, a server can identify multiple devices with the information.

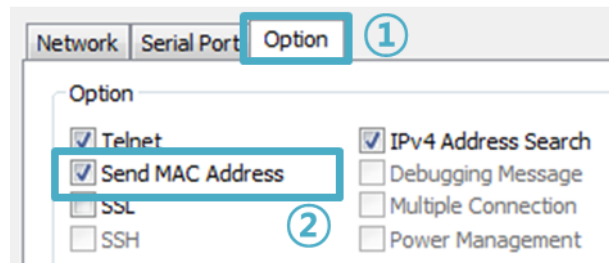

Figure 8-2 setting of Sending MAC Address function

- ① Move to the [Option] tab.
- ② Check the [Send MAC Address] option.

☞ ***Refer to the [Sending MAC Address Function] document on our website for details.***

8.2 Serial Port Tab Functions

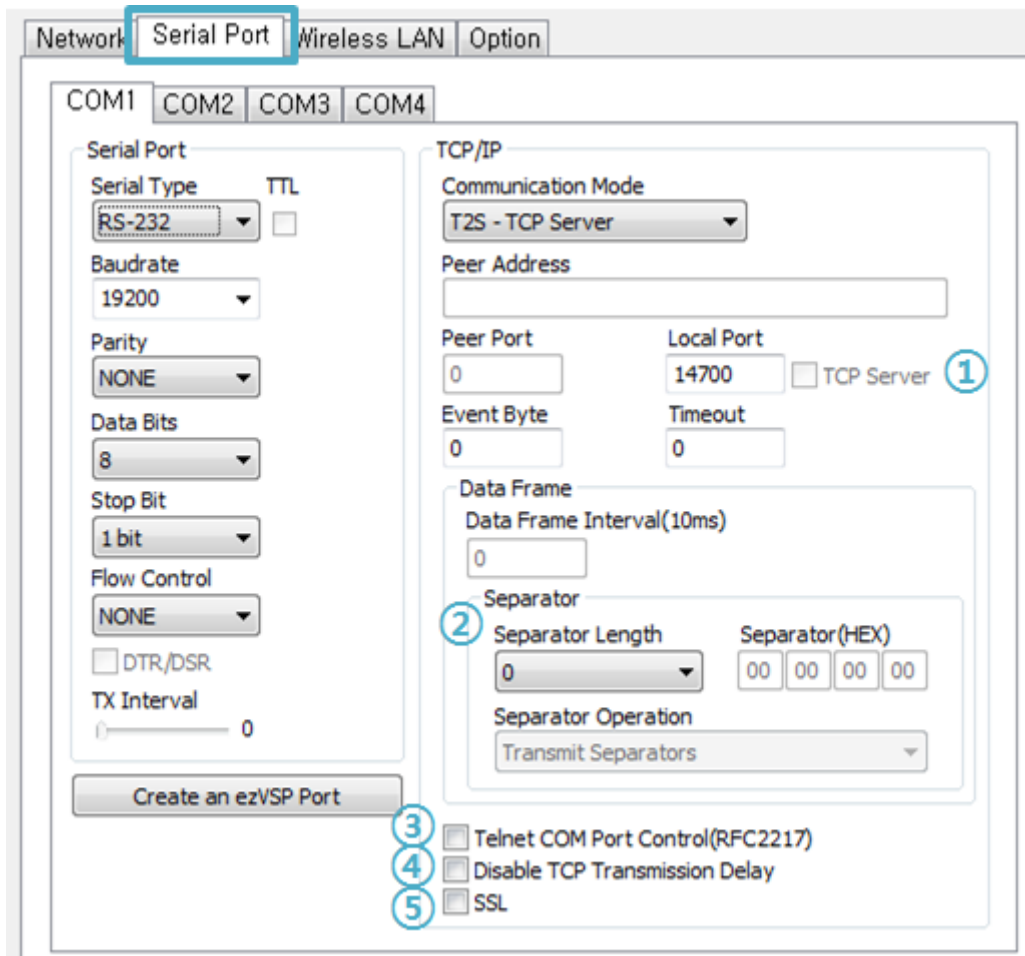

Figure 8-3 serial port tab functions

8.2.1 TCP Server / Client mode - ①

This mode is available on TCP client mode only. In this mode, you do not need to change the mode for switching between active and passive TCP connection. Note that the [Event Byte] option should be set to more than 1.

Refer to the [TCP Server/Client mode] document on our website for details.

8.2.2 Separator - ②

Using this function, you can control the length of network packets by specific characters.

separator	options
Length	select the length between 0 ~ 4 bytes
Operation	Transmit Separators without additional bytes
	Transmit Separators + 1 byte
	Transmit Separators + 2 bytes

Table 8-1 separator

☞ ***Refer to the [Separator Function] document on our website for details.***

8.2.3 TELNET COM port Control Option (RFC 2217) - ③

This option is for sending and receiving serial port states between two devices. You can send and receive control signals such as RTS/CTS when the states are changed.

☞ ***Refer to the [TELNET COM Port Control Option] document on our website for details.***

8.2.4 Disable TCP Transmission Delay - ④

If you use this option, CSC-H64 sends the data from the serial port to WLAN as quickly as possible.

8.2.5 SSL - ⑤

It transmits and receives data with a SSL secure protocol. Refer to 7.1 SSL for details.

☞ ***CSC-H64's Data Frame interval is configured to 2byte data interval. Before sending data from the serial port to LAN, CSC-H64 gathers data in the buffer. If there is no data during the time configured in the 2byte data interval, it will send data gathered until then to the network.***

8.1 Additional Functions

8.1.1 Factory Reset

It is a function to physically initialize all the settings. You can save a setting to user-defined ENV area and use it as default values by the factory reset. However, if you do not use the area, Factory Reset uses the original factory default as its default values.

- Using Factory Reset

- ① Enter the Button setup mode (LEDs blinks).
- ② Press the function button over 10 seconds (LEDs will be ON sequentially).
- ③ Factory Reset will be automatically implemented to default values.
- ④ Reboot.

- Setting custom default values

- ① Change the mode to Button setup mode
- ② Save custom default values by reading [Serial] tab of ezManager or serial configuration commands.
- ③ Input the command below through serial port.

b	<SPACE>	3c5a	<CR>
---	---------	------	------

- ④ After step ③(response code: 701), current values in the SRAM is saved in user-defined ENV area and the values will be always used for [Factory Reset].

9 Checklist in Trouble

When you have problem with CSC-H64, make sure all the followings first.

9.1 Connection Problem over TCP/IP

- Connection with the network

Check if CSC-H64 is successfully connected in network.



Symptoms	LED status
Not connecting a LAN cable or a USB WLAN adapter	RX1 and TX1 LED blink alternately 
Not connecting to the WLAN	RX2 and TX2 LED blink alternately 
Without obtaining an IP address by DHCP	STS LED blinks 4 times at once 

Table 9-1 LED status according to symptoms

- Checking parameters related with TCP/IP

When CSC-H64 has a private IP address, an IP address of a PC and CSC-H64 need to be on the same network. Check if the IP address and local port number are correct. In the case of a fixed IP address, related items such as subnet mask, gateway IP address and DNS IP address should be configured.

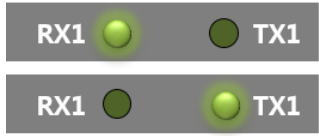
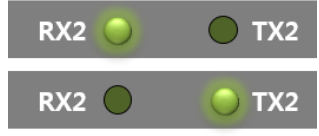
TCP Server side	TCP Client side
Local IP Address, Local Port, Subnet Mask, Gateway IP Address, DNS IP Address and etc.	Local IP Address, Server's IP Address, Server's Port, Subnet Mask, Gateway IP Address, DNS IP Address, and etc.

Table 9-2 major parameters related with TCP/IP

- PING Test

Confirm the connection over the network by PING test. If CSC-H64 does not send any reply from the request, check the network environment.

- Network Firewall

In the case of networks with strong security, the access may be denied by their firewall. Under this circumstance, consult the network administrator to release ports you want to use. (Ex: TCP 14700, TCP 80)

- Communication Mode

To make TCP connection, both a server and client must exist. If there are only servers or clients, TCP connection cannot be established.

9.2 Data Communication Problem on the Serial Port

- Connection of Pins

Check if each connection of pins is right. Refer to the chapter 1.6.7 Serial interface to find out the pin assignment. In the case of using a cable, you should choose the right type of cable for the device.

☞ ***You must connect the Ground pin to your device when using RS422 or RS485 as well as RS232.***

- Setting parameters

Check if all the serial port parameters such as Baud Rate, Data bit, Stop bit and Parity are properly set.

☞ ***Please contact us if you have any questions about above steps or our products.***

10 Technical Support and Warranty

10.1 Technical Support

If you have any question regarding operation of the product, visit Customer Support FAQ corner and the message board on Sollae Systems' web site or send us an email at the following address:

- E-mail: support@eztcp.com
- Website Address for Customer Support: <https://www.eztcp.com/en/support/>

10.2 Warranty

10.2.1 Refund

Upon the customer's request to refund the product within two weeks after purchase, Sollae Systems will refund the product.

10.2.2 Free Repair Services

For product failures occurring within 2 years after purchase, Sollae Systems provides free repair services or exchange the product. However, if the product failure is due to user's fault, repair service fees will be charged or the product will be replaced at user's expense.

10.2.3 Charged Repair Services

For product failures occurring after the warranty period (2 years) or resulting from user's fault, repair service fees will be charged and the product will be replaced at user's expense.

11 Precaution and Exemption from Liability

11.1 Precaution

- Sollae Systems is not responsible for product failures occurring due to user's alternation of the product.
- Specifications of the product are subject to change without prior notice for performance improvement.
- Sollae Systems does not guarantee successful operation of the product if the product was used under conditions deviating from the product specifications.
- Reverse engineering of firmware and applications provided by Sollae Systems is prohibited.
- Use of firmware and applications provided by Sollae Systems for purposes other than those for which they were designed is prohibited.
- Do not use the product in an extremely cold or hot place or in a place where vibration is severe.
- Do not use the product in an environment in which humidity is high or a lot of oil exists.
- Do not use the product where there is caustic or combustible gas.
- Sollae Systems does not guarantee normal operation of the product under the conditions a lot of noise exists.
- Do not use the product for a purpose that requires exceptional quality and reliability relating to user's injuries or accidents – aerospace, aviation, health care, nuclear power, transportation, and safety purposes.
- Sollae Systems is not responsible for any accident or damage occurring while using the product.

11.2 Exemption from Liability

11.2.1 English version

In no event shall Sollae Systems Co., Ltd. and its distributors be liable for any damages whatsoever (including, without limitation, damages for loss of profit, operating cost for commercial interruption, loss of information, or any other financial loss) from the use or inability to use the CSC-H64 even if Sollae Systems Co., Ltd. or its distributors have been informed of such damages.

The CSC-H64 is not designed and not authorized for use in military applications, in nuclear applications, in airport applications or for use in applications involving explosives, or in medical applications, or for use in security alarm, or for use in a fire alarm, or in applications involving elevators, or in embedded applications in vehicles such as but not limited to cars, planes, trucks, boats, aircraft, helicopters, etc.

In the same way, the CSC-H64 is not designed, or intended, or authorized to test, develop, or be built into applications where failure could create a dangerous situation that may result in financial losses, damage to property, personal injury, or the death of people or animals. If you use the CSC-H64 voluntarily or involuntarily for such unauthorized applications, you agree to subtract Sollae Systems Co., Ltd. and its distributors from all liability for any claim for compensation.

Sollae Systems Co., Ltd. and its distributors entire liability and your exclusive remedy shall be Sollae Systems Co., Ltd. and its distributors option for the return of the price paid for, or repair, or replacement of the CSC-H64.

Sollae Systems Co., Ltd. and its distributors disclaim all other warranties, either expressed or implied, including, but not limited to, the implied warranties of merchantability and fitness for a particular purpose, with respect to the CSC-H64 including accompanying written material, hardware and firmware.

11.2.2 French version

- Documentation

La documentation du boîtier CSC-H64 est conçue avec la plus grande attention. Tous les efforts ont été mis en œuvre pour éviter les anomalies. Toutefois, nous ne pouvons garantir que cette documentation soit à 100% exempt de toute erreur. Les informations présentes dans cette documentation sont données à titre indicatif. Les caractéristiques techniques peuvent changer à tout moment sans aucun préavis dans le but d'améliorer la qualité et les possibilités des produits.

- Copyright et appellations commerciales

Toutes les marques, les procédés, les références et les appellations commerciales des produits cités dans la documentation appartiennent à leur propriétaire et Fabricant respectif.

- Conditions d'utilisations et limite de responsabilité

En aucun cas Sollae Systems Co., Ltd. ou un de ses distributeurs ne pourra être tenu responsable de dommages quels qu'ils soient (intégrant, mais sans limitation, les dommages pour perte de bénéfice commercial, interruption d'exploitation commerciale, perte d'informations et de données à caractère commercial ou de toute autre perte financière) provenant de l'utilisation ou de l'incapacité à pouvoir utiliser le boîtier CSC-H64, même si Sollae Systems Co., Ltd. ou un de ses distributeurs a été informé de la possibilité de tels dommages.

Le boîtier CSC-H64 est exclusivement prévu pour un usage en intérieur, dans un environnement sec et non poussiéreux. Le boîtier CSC-H64 n'est pas prévu, ni autorisé pour être utilisé en extérieur, ni de façon embarquée dans des engins mobiles de quelque nature que ce soit (voiture, camion, train, avion, etc...), ni en milieu explosif, ni dans des enceintes nucléaires, ni dans des ascenseurs, ni dans des aéroports, ni dans des enceintes hospitaliers, ni pour des applications à caractère médical, ni dans des dispositifs de détection et d'alerte anti-intrusion, ni dans des dispositifs de détection et d'alerte anti-incendie, ni dans des dispositifs d'alarme GTC, ni pour des applications militaires.

De même, le boîtier CSC-H64 n'est pas conçu, ni destiné, ni autorisé pour expérimenter, développer ou être intégré au sein d'applications dans lesquelles une défaillance de celui-ci pourrait créer une situation dangereuse pouvant entraîner des pertes financières, des dégâts matériel, des blessures corporelles ou la mort de personnes ou d'animaux. Si vous

utilisez le boîtier CSC-H64 volontairement ou involontairement pour de telles applications non autorisées, vous vous engagez à soustraire Sollae Systems Co., Ltd. et ses distributeurs de toute responsabilité et de toute demande de dédommagement.

En cas de litige, l'entière responsabilité de Sollae Systems Co., Ltd. et de ses distributeurs vis-à-vis de votre recours durant la période de garantie se limitera exclusivement selon le choix de Sollae Systems Co., Ltd. et de ses distributeurs au remboursement de votre produit ou de sa réparation ou de son échange. Sollae Systems Co., Ltd. et ses distributeurs démentent toutes autres garanties, exprimées ou implicites.

Tous les boîtiers CSC-H64 sont testés avant expédition. Toute utilisation en dehors des spécifications et limites indiquées dans cette documentation ainsi que les court-circuit, les chocs, les utilisations non autorisées, pourront affecter la fiabilité, créer des dysfonctionnements et/ou la destruction du boîtier CSC-H64 sans que la responsabilité de Sollae Systems Co., Ltd. et de ses distributeurs ne puissent être mise en cause, ni que le boîtier CSC-H64 puisse être échangé au titre de la garantie.

- Rappel sur l'évacuation des équipements électroniques usagés

Le symbole de la poubelle barré présent sur le boîtier CSC-H64 indique que vous ne pouvez pas vous débarrasser de ce dernier de la même façon que vos déchets courants. Au contraire, vous êtes responsable de l'évacuation du boîtier CSC-H64 lorsqu'il arrive en fin de vie (ou qu'il est hors d'usage) et à cet effet, vous êtes tenu de le remettre à un point de collecte agréé pour le recyclage des équipements électriques et électroniques usagés. Le tri, l'évacuation et le recyclage séparés de vos équipements usagés permettent de préserver les ressources naturelles et de s'assurer que ces équipements sont recyclés dans le respect de la santé humaine et de l'environnement. Pour plus d'informations sur les lieux de collecte des équipements électroniques usagés, contacter votre mairie ou votre service local de traitement des déchets.

12 Revision History

Date	Version	Description	Author
2015.05.21	1.0	○ Initial release	Amy Kim
2016.03.22	1.2	○ Add explanation for telnet login.	Peter
2017.08.24.	1.3	○ Improve descriptions of table 1-4, 1-5 and 1-6 ○ Update contents of 6.2.1. Using Telnet ○ Correct some errors and expressions	Roy LEE
2022.07.28.	1.4	○ Add a notification about FCC	Roy Lee
2022.08.26.	1.5	○ Updated URLs of websites ○ Removed the Components section ○ Removed the Related materials section	Roy Lee